



PhD Thesis

Dea Siggaard Stenbæk

Sex-steroid hormone manipulations and serotonergic neurotransmission in relation to verbal affective memory recall, simple reaction time, and mental distress

Academic Supervisor: Steen Gregers Hasselbalch

Submitted: 14/7/2015

Title: Sex-steroid hormone manipulations and serotonergic neurotransmission in relation to verbal affective memory recall, simple reaction time, and mental distress

Author: Dea Siggaard Stenbæk, MSc. Psychology

Department: Neurobiology Research Unit, Neuroscience Center, Copenhagen University Hospital Rigshospitalet, Denmark

Institution: Faculty of Health and Medical Sciences, University of Copenhagen, Denmark

Date of submission: 14/7/2015

Academic Supervisors:

Steen Gregers Hasselbalch (main supervisor), MD, DMSc, professor, Neurobiology Research Unit and Danish Dementia Research Centre, Department of Neurology, Copenhagen University Hospital, Rigshospitalet

Vibe Gedsø Frøkjær, MD, PhD, senior researcher, Neurobiology Research Unit, Department of Neurology, Copenhagen University Hospital, Rigshospitalet

Gitte Moos Knudsen, MD, DMSc, professor, Neurobiology Research Unit, Department of Neurology, Copenhagen University Hospital, Rigshospitalet

Evaluating Committee:

Lone Schmidt (chairman), DMSc, PhD, associate professor, Department of Public Health, Copenhagen University

Inger Sundström Poromaa, MD, PhD, professor, Department of Women's and Children's Health, Uppsala University

Rebecca Elliott, PhD, Senior Research Fellow in Cognitive Neuroscience, Institute of Brain, Behaviour and Mental Health, Manchester University

ACKNOWLEDGEMENTS

I am very grateful to the volunteers and patients who participated in the included studies of this thesis. I am also grateful and wish to thank all my colleagues at Neurobiology Research Unit and my co-authors from other institutions who contributed to the studies with inspiring collaborations. In particular, I would like to thank my closest colleagues: Christian Gaden Jensen, Liv Vadskjær Hjordt, Patrick Fisher, Peter Jensen, Claus Svarer, Louise Møller Jørgensen, Per Jensen, Melanie Ganz-Benjaminsen, Vincent Bileveau, Brenda McMahon, Sophie da Cunha-Bang, Mette Haahr, Lars Pinborg, Vibeke Dam, Jon Lansner, Hrefna Einarsdottir, Silja Back, Emil Andersen, and Nanna Hansen, for support, inspiration, and good spirit. I thank Dorthe Givard, Lone Freyr, Agnete Dyssegaard, and Gerda Thomsen, for administrative and technical assistance in addition to personal support, and for taking good care of the study participants. I thank Klaus Holst and Esben Budtz-Jørgensen for expert advice and assistance, and for elaborative discussions of statistical tools. I am grateful for having so many bright and skilled colleagues around me.

I am most grateful for excellent supervision and guidance from Steen Gregers Hasselbalch, who supervised this thesis in its whole, Vibe Gedsø Frøkjær, who I could not have conducted my work without and who allocated valuable time to supervise me throughout my study period, in particular with regards to the sex hormone aspects, and Gitte Moos Knudsen, who supervised the general methodological aspects and who supported and inspired me in many ways throughout.

I thank the Faculty of Health Sciences, Copenhagen University, The Lundbeck Foundation, the Danish Research Council for Independent Research and MSD, Denmark, for financial support of the included studies.

Last, but not least, I am happy to thank with all my heart my entire family for supporting me through my study period, in particular, my parents Søren Stenbæk and Sisse Siggaard Jensen and my husband's parents Lillan Rasmussen and Michael Nielsen, and finally my beloved husband Thomas Fonnesbæk and our three wonderful children Nina, Noah, and Axel, who through their mere being is a constant source of love, energy, and inspiration. Thank you.

Dea Siggaard Stenbæk

Copenhagen, July 2015

THESIS SUMMARY

This thesis focuses on sex-steroid hormone manipulations and pre- and post-synaptic serotonergic involvement in relation to verbal affective memory, information processing speed, and mental distress in (1) young healthy women, (2) young healthy men and women and, (3) young women undergoing in vitro fertilization. The potential moderating role of the personality trait Neuroticism on effects of sex-steroid hormone manipulations on verbal affective memory, information processing speed, and mental distress is also explored.

The prevalence of major depression is twice as high for women compared to men, and women exhibit increased risk of depressive symptoms and mood disturbances in life phases, where sex hormones fluctuate or decline rapidly, such as menopausal transition and postpartum. Interestingly, ovarian hormones may modulate important molecular mechanisms underlying emotional processes, i.e. serotonin (5-HT) signaling, which is known to be critically involved in memory function and mood. So-called mood congruent- or affective processing biases; i.e. enhanced encoding, recognition, and recall of negative information compared to positive information, are core cognitive features of major depression symptomatology and are also exhibited by individuals with high risk for major depression. As such, affective processing biases in memory may be useful to probe the depressogenic effects of ovarian hormone manipulations.

The thesis is based on 3 studies. In study 1, we examined the effects of undergoing Gonadotropin-Releasing Hormone agonist (GnRHa) versus GnRH antagonist protocol for assisted reproductive technology (ART) on measures of mental distress and mood fluctuations in young sub-fertile women. We further investigated the moderating role of personality trait, Neuroticism, on such effects. In study 2, we set out to examine the association between cerebral 5-HT₄ receptor binding, as an inversely related marker of serotonergic tonus, and the Danish Verbal Affective Memory Test-24 (VAMT-24) to test the sensitivity of the VAMT-24 to 5-HT levels in healthy individuals. In study 3, we examined the effects of a pharmacologically induced ovarian hormone fluctuation with a GnRHa in young healthy women. Here we tested direct effects and mediated effects through changes in the 5-HT transporter; a key regulator of synaptic 5-HT, on VAMT-24, simple reaction time, and measures of mental distress including serial daily reports of mood during intervention. We further investigated the moderating role of personality trait Neuroticism on such effects.

We observed a highly significant inverse association between 5-HT₄ receptor binding and VAMT-24, suggesting that VAMT-24 is a sensitive marker of 5-HT levels in healthy individuals (study 2). However, we found no significant effects of GnRHa intervention on VAMT-24 (study 3) or self-reported mental distress (study 1 and 3) and no mediating effects through changes in 5-HT transporter function (study 3). In study 3, we found that GnRHa intervention increased simple reaction time and that mood at baseline interacted with intervention effects so that women high in mood disturbances at baseline exhibited more labile mood during GnRHa intervention. Neuroticism was associated with increased mental distress at baseline and likewise moderated serial daily reported mood disturbances during intervention (study 1 and 3). Low and high Neuroticism scores were also associated with lower probability of positive pregnancy test in women undergoing ART (study 1).

In conclusion, the results obtained in this thesis suggest that in healthy young women bottom-up processes, i.e. speed of information processing, may be compromised by transient hormone fluctuations, whereas top-down processes, i.e. verbal affective memory recall (VAMT-24), appear not to be affected. Importantly, the susceptibility to hormone-triggered mood fluctuations appears to depend on both state and trait aspects of mental status in a subgroup of women. Future studies in young healthy women may benefit from a combination of pharmacological challenges to hormone production and experimentally induced stress or the use of high-risk populations to get a more complete understanding of the risk mechanisms involved in a depressive response to ovarian hormone fluctuations in real-life settings.

DANSK RESUMÉ

Denne afhandling fokuserer på kønshormonmanipulation samt præ- og post-synaptisk serotonerg involvering i relation til verbal affektiv hukommelse, processingshastighed og mentalt distress i (1) unge raske kvinder, (2) unge raske mænd og kvinder og (3) unge kvinder i in vitro fertilitetsbehandling. Ligeledes undersøger vi hvorvidt personlighedstrækket Neuroticisme modererer effekter af kønshormonmanipulation på verbal affektiv hukommelse, processingshastighed og mentalt distress.

Prevalensen af depression er dobbelt så høj for kvinder sammenlignet med mænd og kvinder har øget risiko for udvikling af depressive symptomer og humørforstyrrelser i livsfaser, hvor kønshormonerne fluktuerer eller falder pludseligt, som det er tilfældet ved overgangsalderen og i efterfødselsperioden. I den forbindelse er det interessant, at kønshormoner ser ud til at modulere vigtige molekulære mekanismer af betydning for emotionelle processer, som serotonin (5-HT) neurotransmission, der vides at være kritisk involveret i hukommelsesfunktioner og humørregulering. Såkaldte humørkongruente- eller affektive processeringsbias; øget indkodning, genkendelse og genkaldelse af negativ information sammenlignet med positiv information er centrale kognitive kendetegn ved depressionens symptomatologi og ses også hos individer med høj risiko for depression. Det er derfor muligt at affektive processeringsbias er anvendelige markører for en depressionsfremmende effekt af kønshormonmanipulation.

Denne afhandling er baseret på 3 studier. I studie 1, undersøgte vi effekterne af at gennemgå Gonadotropin-Releasing Hormone agonist (GnRHa) versus GnRH antagonist protokol for assisteret reproduktiv teknologi (ART) på mål for mentalt distress og humørsvingninger i unge sub-fertile kvinder. Ligeledes undersøgte vi hvorvidt personlighedstrækket Neuroticisme modererede sådanne effekter. I studie 2, sigtede vi mod at undersøge associationen mellem cerebral 5-HT₄ receptor binding, som en negativt korreleret markør for serotonerg tonus, og Danish Verbal Affective Memory Test-24 (VAMT-24) med henblik på at efterprøve testens sensitivitet overfor hjernens 5-HT niveau i sunde og raske individer. I studie 3, undersøgte vi effekterne af en farmakologisk induceret kønshormonfluktuation med en GnRHa i unge raske kvinder. Her testede vi direkte effekter og medierede effekter gennem ændringer i 5-HT transporteren; en vigtig regulator af synaptisk 5-HT, på VAMT-24, processingshastighed og mentalt distress inklusiv daglige humør-

rapporteringer under intervention. Ligeledes undersøgte vi hvorvidt personlighedstrækket Neuroticisme modererede sådanne effekter.

Vi fandt en høj-signifikant negativ association mellem 5-HT₄ receptor binding og VAMT-24, der indikerer at VAMT-24 er en sensitiv markør for 5-HT niveauer i sunde og raske individer (studie 2). Vi fandt ingen signifikante effekter af GnRHa intervention på VAMT-24 (studie 3) eller selv-rapporteret mentalt distress (studie 1 og 3) og ingen medierende effekter gennem ændringer i 5-HT transporter binding (studie 3). I studie 3 fandt vi, at GnRHa intervention sænkede processeringshastighed sammenlignet med placebo og at humør ved baseline interagerede med interventionseffekter således, at kvinder med et højt niveau af humørforstyrrelser ved baseline udviste større labilitet i humøret under GnRHa intervention sammenlignet med placebo. Neuroticisme var associeret med højere niveauer af mentalt distress ved baseline og modererede dagligt rapporterede humørsvingninger under intervention (studie 1 og 3). Lave og høje Neuroticisme scores var også associeret med lavere sandsynlighed for et positivt graviditetsresultat for kvinder, der gennemgik ART (studie 1).

Konkluderende peger resultaterne i denne afhandling på, at midlertidige hormonelle fluktuationer kan kompromittere "bottom-up" processer som processeringshastighed, hvorimod "top-down" processer, som ved eksempelvis verbal affektiv hukommelsesgenkald (VAMT-24), ikke ser ud til at påvirkes i unge raske kvinder. Endvidere ser det ud til, at sårbarheden overfor hormonelt igangsatte humørsvingninger afhænger af både trait og state aspekter af mental status i en sub-gruppe af kvinder. Fremtidige studier af unge raske kvinder kunne med fordel anvende en kombination af farmakologisk intervention og eksperimentelt induceret stress eller brug af høj-risiko populationer med henblik på at opnå en mere udførlig forståelse af risiko mekanismerne for at udvikle depressive symptomer i forbindelse med livsfaser, hvor niveauet af kønshormonerne fluktuerer.

TABLE OF CONTENTS

ACKNOWLEDGEMENTS.....	3
THESIS SUMMARY.....	4
DANSK RESUME.....	6
TABLE OF CONTENTS.....	8
LIST OF PAPERS.....	10
ABBREVIATIONS AND TERMINOLOGY	12
INTRODUCTION.....	13
BACKGROUND.....	14
Mood disorders and Major Depression.....	14
Individual risk factors.....	15
Personality traits.....	15
Affective bias in cognition.....	16
Gender and ovarian hormones.....	17
The hypothalamic-pituitary-gonadal (HPG) axis.....	19
Ovarian hormones and the brain.....	20
Estrogens and verbal memory function.....	21
Serotonin (5-HT) neurotransmission.....	30
Interaction between estrogenic and serotonergic systems.....	32
AIMS AND HYPOTHESES.....	34
METHODS AND DESIGNS.....	36
Participants.....	36
Study designs.....	37
Intervention and blinding in study 1 and 3.....	38
Developing a Danish affective memory task (VAMT-24 & 26).....	39
MEASURES.....	40
Verbal Affective Memory Test-24 (VAMT-24).....	40
Simple reaction time.....	41
Personality assessment.....	41
Mental distress, mood, and side effects.....	42
The Profile of Mood States (POMS).....	42
The Perceived Stress Scale (PSS).....	43

The Symptom CheckList-92-Revised (SCL-92-R).....	43
The Major Depression Inventory (MDI).....	43
Positron Emission Tomography (PET) and Magnetic Resonance Imaging (MRI).....	44
Estradiol sampling.....	45
Statistical analyses.....	45
RESULTS.....	48
Study 1.....	48
Study 2.....	51
Study 3.....	53
Cross-study comparisons.....	56
DISCUSSION.....	58
Discussion of main findings.....	58
Effects of ovarian hormone manipulations on mental distress.....	58
Daily mood and the role of Neuroticism.....	60
Effects of ovarian hormone manipulations on reaction time and VAMT-24.....	61
The role of 5-HT.....	63
Methodological considerations.....	64
The use of healthy study participants.....	64
The use of self-report inventories.....	64
Low arousal words and the design of VAMT-24.....	65
CONCLUSIONS AND PERSPECTIVES.....	67
Research perspectives.....	68
Promoting an integrated approach to vulnerability for major depression.....	69
REFERENCES.....	71
APPENDICES (PAPER 1, 2, and 3).....	83

LIST OF PAPERS

1. **Stenbæk DS**, Toftager M, Hjor dt LV, Jensen PS, Holst KK, Bryndorf T, Holland T, Bogstad J, Pinborg A, Horness P, Frokjaer VG. Mental distress and personality in women undergoing GnRH antagonist versus GnRH agonist protocols for assisted reproductive technology. *Human Reproduction*. 2014 Jan; 30(1): 103-10
2. **Stenbæk DS**, Fisher PM, Andersen E, Hjor dt LV, Holst KK, McMahon B, Hasselbalch SG, Frokjaer VG, Knudsen GM. Cerebral serotonin 4 receptor binding inversely associated with affective memory in healthy volunteers. *Social Cognitive and Affective Neuroscience*, submitted May 2015
3. **Stenbæk, DS**, Fisher, PM, Budtz-Jørgensen, E, Pinborg A, Hjor dt, LV, Jensen, PS, Knudsen, GM, Frokjaer, VG. Transient sex-steroid hormone manipulation slows reaction time and increases mood variability but does not affect verbal memory in young healthy women. *Psychological Medicine*, submitted July 2015

Related papers:

Frokjaer VG, Pinborg A, Holst KK, Overgaard A, Henningsson S, Heede M, Larsen EC, Jensen PS, Agn M, Nielsen AP, **Stenbæk DS**, da Cunha-Bang S, Lehel S, Siebner HR, Mikkelsen JD, Svarer C, Knudsen GM. Role of Serotonin Transporter Changes in Depressive Responses to Sex-Steroid Hormone Manipulation: A Positron Emission Tomography Study. *Biol Psychiatry*. 2015 [Epub ahead of print]

Knudsen GM, Jensen PS, Erritzoe D, Baaré WF, Ettrup A, Fisher PM, Gillings N, Hansen HD, Hansen LK, Hasselbalch SG, Henningsson S, Herth MM, Holst KK, Iversen P, Kessing LV, Macoveanu J, Madsen KS, Mortensen EL, Nielsen FÅ, Paulson OB, Siebner HR, **Stenbæk DS**, Svarer C, Jernigan TL, Strother SC, Frokjaer VG. The Center for Integrated Molecular Brain Imaging (Cimbi) database. *Neuroimage*. 2015 [Epub ahead of print]

Jensen CG, Hjordt LV, **Stenbæk DS**, Andersen E, Back SK, Lansner J, Hageman I, Dam H, Porsmose A, Knudsen GM, Frokjaer VG, Hasselbalch SG. Development and psychometric validation of the verbal affective memory test. *Memory*. In press

Stenbæk DS, Hjordt LV, Haahr ME, Worm D, Hansen DL, Mortensen EL, Knudsen GM. Personality characteristics in surgery seeking and non-surgery seeking obese individuals compared to non-obese controls. *Eat Behav*. 2014 Dec;15(4):595-8.

Haahr ME, Hansen DL, Fisher PM, Svarer C, **Stenbæk DS**, Madsen K, Madsen J, Holst JJ, Baaré WF, Hojgaard L, Almdal T, Knudsen GM. Central 5-HT neurotransmission modulates weight loss following gastric bypass surgery in obese individuals. *J Neurosci*. 2015 Apr 8;35(14):5884-9

Stenbæk DS, Jensen CG, Holst KK, Mortensen EL, Knudsen GM, Frokjaer VG. Does Harm Avoidance mediate effects of recollected parental bonding on mental distress in adulthood? *Compr Psychiatry*. 2014 May;55(4):1007-14.

da Cunha-Bang S, **Stenbæk DS**, Holst K, Licht CL, Jensen PS, Frokjaer VG, Mortensen EL, Knudsen GM. Trait aggression and trait impulsivity are not related to frontal cortex 5-HT_{2A} receptor binding in healthy individuals. *Psychiatry Res*. 2013 May 30;212(2):125-31

ABBREVIATIONS AND TERMINOLOGY

5-HT: Serotonin

5-HT₄R: Serotonin 4 Receptor

5-HTT: Serotonin Transporter

ART: Assisted Reproductive Technology

ATD: Acute Tryptophan Depletion

BMI: Body Mass Index

ER: Estrogen Receptor

FFM: Five-Factor-Model

FSH: Follicle-stimulating hormone

GnRH: Gonadotropin-Releasing Hormone

GnRHa: Gonadotropin-Releasing Hormone agonist

HPG-axis: Hypothalamic-Pituitary-Gonadal-axis

HRT: Hormone Replacement Therapy

IMM: Immediate Memory

LH: Luteinizing hormone

LTM: Long Term Memory

MDI: Major Depression Inventory

MRI: Magnetic Resonance Imaging

SCL-92-R: Symptom CheckList-92-Revised

SSRI: Selective Serotonin Reuptake Inhibitor

STM: Short Term Memory

PET: Positron Emission Tomography

POMS: Profile of Mood State

PSS: Perceived Stress Scale

PPD: Post Partum Depression

VAMT-24 and 26: Verbal Affective Memory Test-24 and 26

Major depression and depression are used synonymously

[¹¹C]SB207145 is a PET-tracer for imaging the 5-HT₄ receptor

[¹¹C]DASB is a PET-tracer for imaging the 5-HT transporter

INTRODUCTION

Gender matters when it comes to the prevalence and risk of developing major depression given that women have a two-fold greater risk and are more likely to experience greater symptom severity compared to men. Currently little is known about the risk mechanisms involved in these gender differences, however, several risk paths have been proposed. Epidemiological evidence suggests that women may be especially vulnerable to the development of major depression in life phases, where ovarian hormone levels fluctuate. In particular, fluctuating ovarian hormone levels may moderate important molecular mechanisms involved in affective cognitive features of major depression, i.e. serotonergic neurotransmission. Also, the personality trait Neuroticism, a known risk marker of major depression, has consistently been found to be higher in women compared to men and may moderate the impact of hormone fluctuations in otherwise healthy women.

The background section of this thesis covers a short introduction to mood disorders and their prevalence as well as proposed personality and affective cognitive risk markers of major depression. Next the roles of gender and ovarian hormones are presented and the literature regarding the association between estrogens and verbal memory function is reviewed. Lastly the serotonin (5-HT) system is presented and the proposed interaction between estrogenic and serotonergic systems is outlined.

The thesis includes three studies; two studies on the effects of sex-steroid hormone manipulations on verbal affective memory, mental distress, and daily mood disturbances in (1) 61 premenopausal young healthy women and (2) 83 young sub-fertile women undergoing their first ART-cycle. The thesis further includes a cross-sectional study of the association between 5-HT signalling as indexed by the 5-HT₄ receptor and verbal affective memory in 24 young healthy men and women.

BACKGROUND

Mood Disorders and Major Depression

Mood disorders are among the most commonly diagnosed psychiatric disorders and include depressive episodes and recurrent depressive disorder, manic episodes and bipolar disorder (ICD-10, F30-33) (WHO, 2005). The clinical features of major depression pertain to a constant sense of despair and hopelessness that disrupts the ability to uphold normal activities and relationships during a period of at least 2 weeks. More specifically, depressed individuals experience symptoms such as: Fatigue or loss of energy, feelings of worthlessness or guilt, impaired concentration, indecisiveness, insomnia or hypersomnia, markedly diminished interest or pleasure in almost all activities, restlessness or feeling slowed down, recurring thoughts of death or suicide, and significant weight loss or gain. Bipolar disorder involves fluctuating depressive and manic episodes. The clinical features of a manic episode entails inflated self-esteem or grandiosity, decreased need for sleep, pressure to talk, flight of ideas or racing thoughts, distractibility, increase in goal-directed activity or psychomotor agitation, and excessive involvement in pleasurable activities with high potentials for painful consequences.

Over a life time approximately 10 - 16 % of the population will experience depressive symptoms severe enough to reach diagnostic criteria for major depression (Hasin *et al.*, 2005) with a typical onset in early adulthood (Kessler *et al.*, 2005). For bipolar disorder the life time prevalence is approximately 1- 3% (Pini *et al.*, 2005) with a typical onset in late adolescence or early adulthood. Apart from the difference in time of onset, it is not currently clear whether unipolar and bipolar disorders are categorically distinct or whether they represent a continuum (Akiskal and Benazzi, 2006). The negative impact of major depression is pervasive, with a dose-dependent association between severity and the extent of disability (Ormel and Silva, 1995) and a doubling of social and occupational disability with early onset of major depression (Ormel *et al.*, 1999). The negative impact of major depression on physical health and mortality is also substantial; the detrimental effects of major depression on health status are greater than that those observed for major chronic illnesses (Moussavi *et al.*, 2007). Therefore understanding more about who has increased risk for developing major depression and the mechanisms involved are crucial for the prevention and management of the disorder.

Individual risk factors

Vulnerability can be conceptualized as internal and stable features of the individual that predisposes to the development of psychopathology, typically in the context of stressful life events (Caspi *et al.*, 2003). A number of vulnerability factors for the development of major depression have been proposed including biological, psychological, and environmental factors (Gilbert, 2004), however, this thesis covers mainly the two first categories. Great effort has been put into the empirical investigation of trait-based features of personality in relation to major depression under the assumption that such features are implicated in the way that emotive and cognitive processes are organized (Klein *et al.*, 2011). Trait-based features of personality that may promote negative affective biases in processing of emotional stimuli have been a growing field in affective sciences (Everaerd *et al.*, 2015) and negative affective biases in cognition in relation to major depression independent of personality is also a subject receiving a great deal of attention (Elliott *et al.*, 2011, Miskowiak and Carvalho, 2014). Finally, according to the serotonergic vulnerability hypothesis, personality risk traits and affective biases in cognition factors may be related to major depression through compromised serotonergic neurotransmission (Jans *et al.*, 2006).

Personality traits

Even though no universally accepted definition of personality exists, it is a broad branch of psychological science concerned with long-lasting, essential features of an individual, continuing to exert influence on cognition, emotion and behaviour (Ewen, 2010). The Five-Factor-Model (FFM) is a widely applied example of how to envision personality as organised hierarchically, with lower order specific traits combining to define five broad global factors (Costa and McCrae, 1995). It is a perspective on personality that adopts a trait theoretical approach and which has accumulated converging evidence regarding its stability, heritability and consensual validation, cross-cultural and predictive utility (Costa and McCrae, 1997).

Formulated by Costa and McCrae (2003), the FFM rests on three central components labelled basic tendencies, characteristic adaptations and the self-concept. According to this understanding, basic tendencies refer to enduring biologically based capacities and tendencies of the individual, whereas characteristic adaptations are the acquired structures that a person develops in interplay with surrounding environments to accommodate and adjust to life conditions and changes over time. The self-concept is technically a part of the

acquired characteristic adaptations through which the individual understands him- or herself. The FFM specifies personality traits in dimensional terms, characterizing the individual along a continuum signifying the degree to which they exhibit certain traits as quantified by the self-reported NEO Personality Inventory-Revised (NEO PI-R). This is based on the assumption that such traits are normally distributed in the general population. By phrasing traits as basic tendencies, the authors also emphasise the probabilistic as opposed to deterministic nature of personality traits (McCrae and Costa, 2003). Of the five major domains shown in Figure 1, the domain of Neuroticism represents a known risk factor for mood disorders and will be introduced in more detail in the method section of the thesis.

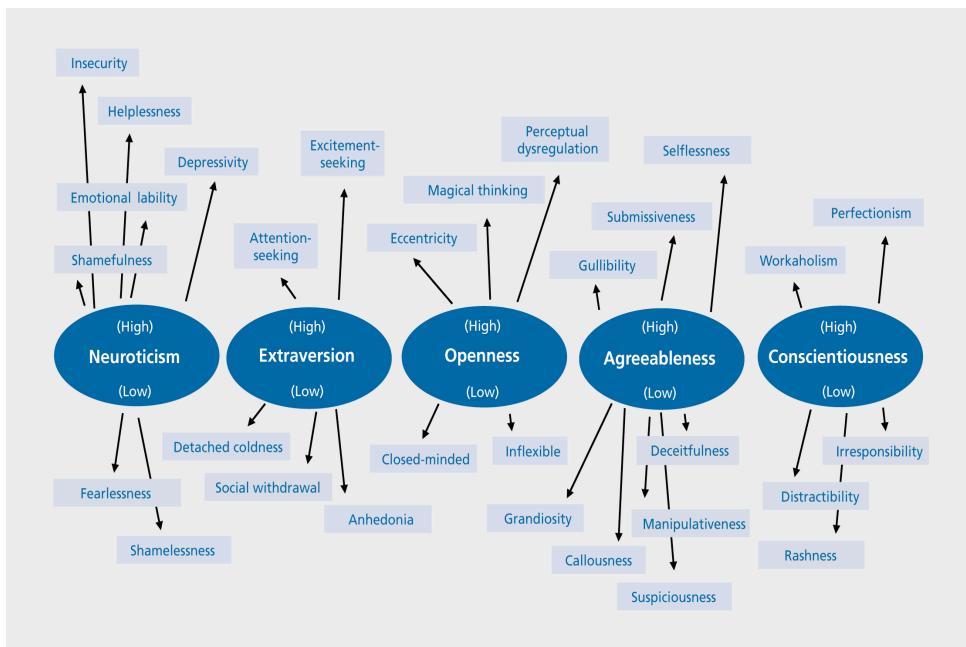

Figure 1: An overview of the constituent personality domains in the FFM. For illustrative purposes the profiles of high and low levels of the domains are described.

Affective bias in cognition

Affective cognition refers broadly to tasks, in which emotional stimuli must be categorized, remembered, attended to, or actively inhibited. Many of the cognitive changes found in patients diagnosed with major depression reflect an information processing bias, in which the importance of negatively valenced information is exaggerated (Elliott *et al.*, 2011). These so-called mood congruent- or negative biases in affective processing are thought to play a major cognitive role in the etiology of major depression (Beck, 2008), and contribute to the emotional imbalance by favoring negative information over positive information at different levels of information processing (Dagleish, 2004, Elliott *et al.*, 2011). As such they may work

to initiate, sustain, or worsen the depressed state by supporting the rumination of negative or threatening thoughts and feelings (Bistricky *et al.*, 2011, Weightman *et al.*, 2014), and appear to have a distinct neural architecture (Elliott *et al.*, 2002). Negative biases are also found in individuals with high risk for depression, which suggests that they may be involved in vulnerability traits to depression (Mathews and MacLeod, 2005).

Many different types of paradigms have been developed to assess affective cognition, i. e. processing of emotional images and music, face processing tasks, memory and attention bias tasks, and tasks related to social and moral emotions (Elliot *et al.*, 2011). One of the most applied affective tasks pertains to encoding, learning and subsequent recall of emotional words (affective memory tasks). Until now no validated Danish verbal affective memory test has been available for the research community involved in affective science in Denmark. The development and validation of a Danish verbal affective memory test was therefore undertaken by our research group (Jensen *et al.*, in press), which is described in detail in the method section of the thesis.

Gender and ovarian hormones

Another major risk factor for mood disorders is gender. The prevalence of major depression is twice as high for women compared to men (Kessler *et al.*, 1993) and women are also more likely to experience greater symptom severity concurrent with higher rates of comorbid anxiety, somatoform and eating disorders (Marcus *et al.*, 2008). However, the determinants leading to gender differences in major depression are far from established (Piccinelli and Wilkinson, 2000). Epidemiological evidence imply increased risk of depression and mood disturbances in life phases, where ovarian hormones fluctuate or decline rapidly (Deecher *et al.*, 2008), such as postpartum (Gavin *et al.*, 2005, Le Strat *et al.*, 2011, O'Hara, 1996) and menopausal transition (Freeman *et al.*, 2014). Thus, from the perspective of a lifetime, periods with increased fluctuations in estrogen concentrations correspond to increased prevalence rates for major depression in women. Figure 2 below illustrates a life cycle of estrogens and how levels of estrogens are increased during the reproductive period. It further shows how puberty and perimenopause estrogen concentrations are marked by pronounced fluctuations.

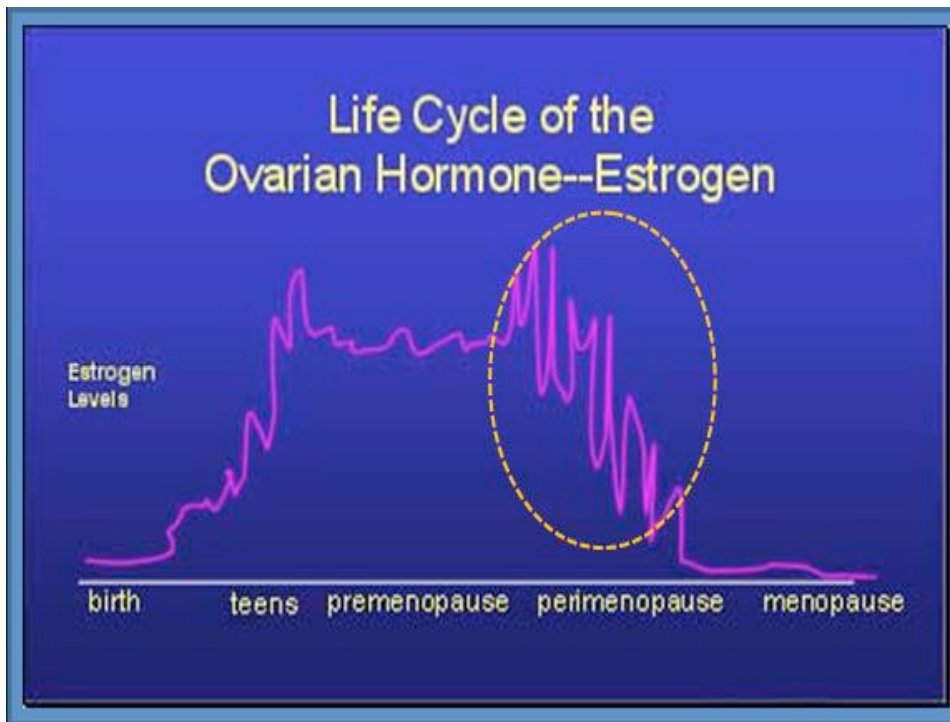

Figure 2: The figure shows a schematic overview of a life cycle of estrogens. The perimenopause is highlighted as an adult risk phase for developing major depression. Adapted from Speroff and Fritz, (2005).

Post- or peripartum depression (PPD) has a prevalence of approximately 19 % and is considered a severe public health concern (Gavin *et al.*, 2005, Le Strat *et al.*, 2011, O'Hara, 1996). The transient period that many new mothers experience called postpartum blues is characterized by e.g. mood swings and crying spells and arises concurrent to the drop in ovarian hormones produced by the placenta during pregnancy (Nott *et al.*, 1976). Postpartum blues is in itself a non-pathological condition but may increase the risk for developing PPD (O'Hara *et al.*, 1991). The PPD incidence peaks early in the postpartum period at day 10 to 19 (Munk-Olsen *et al.*, 2006), where it affects not only the mother but also her ability to attend to and care for a newborn with implications for infant development (Evans *et al.*, 2012, Pearson *et al.*, 2011, Stein *et al.*, 2008) and future mental health on part of the child (Goodman *et al.*, 2011, Pearson *et al.*, 2013).

Another life phase where ovarian hormones fluctuate is during the menopausal transition. The menopausal transition is divided into an early stage and a late stage, where the early stage is marked by variability in menstrual cycle length ≥ 7 days in consecutive cycles and the late stage is marked by amenorrhea ≥ 60 days increased variability in menstrual cycle length (Harlow *et al.*, 2012). The best predictor of a depressive response appears to be the magnitude by which estradiol levels fluctuate around a woman's own mean (Freeman *et al.*, 2006). When the menopause is established and final menstrual period has occurred (12

months of amenorrhea), levels of estradiol stabilize and the risk of depressive symptoms decreases (Freeman *et al.*, 2013). However, to date very little is known about the risk mechanisms involved in how ovarian hormone fluctuations trigger mood disturbances.

The hypothalamic-pituitary-gonadal (HPG) axis

The ovaries are the primary reproductive organs in women, known as gonads. Ovarian hormone production of estrogens (estrone, estriol, and estradiol) and progesterone is part of the endocrine system, which refers to a collection of glands that secrete hormones directly into the circulatory system of the body (Einstein, 2007). The co-operational effects of the hypothalamus, pituitary gland, and gonads are referred to as the hypothalamic-pituitary-gonadal (HPG) axis, which is pivotal in the development and governance of the body's reproductive and immune systems. Within this axis in women, the hypothalamus secretes gonadotropin-releasing hormone (GnRH), the pituitary gland produces luteinizing hormone (LH) and follicle-stimulating hormone (FSH), and the ovaries produce estrogens. The intricate interplay of these hormones regulates menstrual and ovarian cycles in women (Sherman and Korenman, 1975) and the activation or deactivation of the HPG-axis also regulates female life cycles, i. e. onset of puberty and menopause (Hoyt and Falconi, 2015).

A gonadotrophin Releasing Hormone agonist (GnRHa) is a synthetic peptide modeled from the hypothalamic neurohormone GnRH, which elicits the release of pituitary ovarian hormones FSH and LH through its interaction with GnRH receptors (Millar *et al.*, 2004). Pharmacological intervention with GnRHa has been shown to induce a biphasic ovarian hormone response (Thomas *et al.*, 1986); after initial stimulation of the HPG axis, GnRH receptors desensitize and consequently ovarian hormone production is suppressed to menopausal levels within about 10-14 days (Figure 3). Pretreatment with a GnRHa is essential in *in vitro* fertilization (Barlow, 1998), where it suppresses spontaneous ovulation as part of a controlled ovarian hyperstimulation procedure to ensure the retrieval of multiple mature eggs for fertilization. GnRHa is also used in the treatment of hormonally sensitive cancers (Emons *et al.*, 2003), where hypogonadism decreases the risk of recurrence, and in the medical management of precocious puberty, menorrhagia, endometriosis, adenomyosis, and uterine fibroids.

Importantly, the use of GnRHa can be utilized as an experimental risk model for mood disorders, i.e. major depression, as the hormonal response provides a unique opportunity to study how fluctuating ovarian hormones affects brain and behavior.

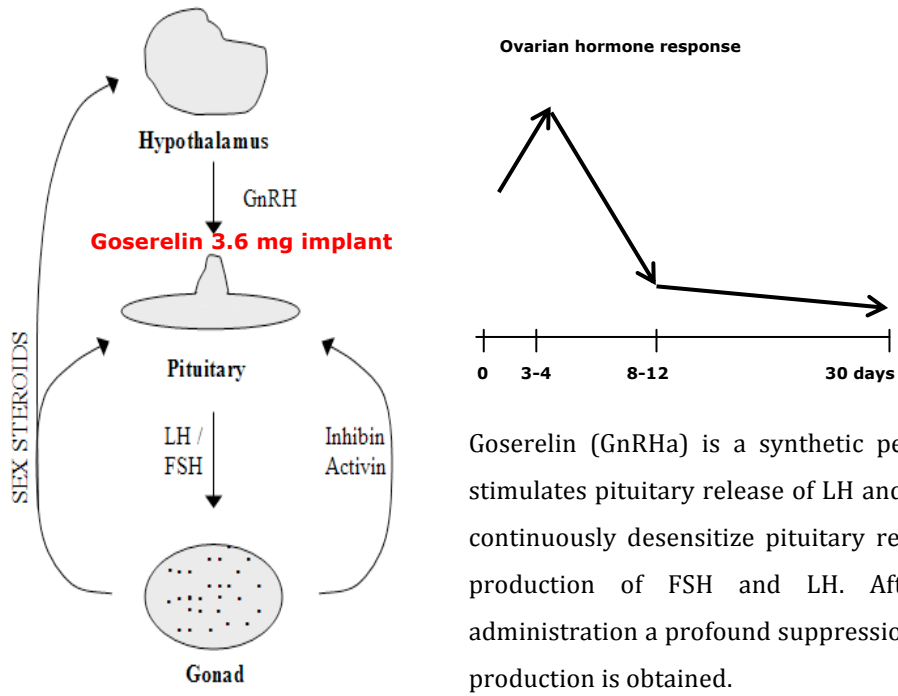

Goserelin (GnRHa) is a synthetic peptide, which initially stimulates pituitary release of LH and FSH, but when given continuously desensitize pituitary receptors and decrease production of FSH and LH. After about 10 days administration a profound suppression of ovarian hormone production is obtained.

Figure 3: The figure shows how to Utilize GnRHa as a risk model for major depression in healthy women

Ovarian hormones and the brain

Ovarian hormones serve to structure and maintain the neuroendocrine milieu of the female brain throughout life (Chakraborti *et al.*, 2007, McEwen *et al.*, 2012). They have a low molecular weight and are lipophilic, which makes it easy for them to cross the blood-brain barrier. In the brain they are neuroactive steroids and are believed to influence the neuroendocrine milieu through genomic mechanisms, where they bind to their intracellular receptors and modulate transcription and protein synthesis (McEwen, 1994). Emerging evidence suggest that estrogens have complex actions in brain regions, e.g. hypothalamus, the mesolimbic system, amygdala, hippocampus, and the cerebral cortex, that regulate various cognitive functions and the hypothalamo-pituitary-adrenal axis (Chakraborti *et al.*, 2007). Estradiol receptors (ERs) are predominantly located in the limbic system, with subtypes (ER α and ER β) apparently dominating in hypothalamus and amygdala and in hippocampus,

thalamus, and entorhinal cortex, respectively (Barth *et al.*, 2015), suggesting that estrogens play a role in affective processing and memory (Fink *et al.*, 1998, Fink *et al.*, 1996).

Indeed, neuroimaging studies of naturally cycling women have shown effects of ovarian steroids on activation in regions underlying emotional and cognitive processes (Toffoletto *et al.*, 2014). In peri- and postmenopausal women decreased activation with acute hormone withdrawal and increased activation with HRT in frontal regions during cognitive performance has been observed (Comasco *et al.*, 2014). Furthermore, estrogenic actions have been proposed to be associated with specific cognitive functions and especially with the cognitive domain of verbal memory (Sherwin, 1994, 1998, 2012).

Estrogens and verbal memory function

In premenopausal women oral contraceptives (ethinylestradiol and progestins) enhance verbal memory (Gogos *et al.*, 2014) and some studies across phases of the menstrual cycle suggest improvements in verbal memory/fluency performance in the late follicular or midluteal phase characterized by high estradiol levels (Sundström Poromaa and Gingnell, 2014). Decreased verbal memory performances have been shown in women during the peripartum period (Glynn, 2010, Henry and Rendell, 2007) and menopausal transition period (Weber *et al.*, 2014), where ovarian hormones fluctuate and decline, which can in some cases be alleviated with hormone replacement therapy (HRT) (Maki and Sundermann, 2009). However, the effect of HRT on verbal memory function after the menopause is established is ambiguous (Hogervorst and Bandelow, 2010) and may depend on the time elapsed between menopause and initiation of HRT (Sherwin, 2009). Randomized controlled studies of surgically postmenopausal women have shown surgery-related impairments in verbal episodic memory (Henderson and Sherwin, 2007) and have supported a protective effect of HRT on verbal memory following surgery (Sherwin, 2005).

However, although the majority of studies point to an association between estrogens and verbal memory, as can be seen in Table 1 below, the quality of studies differs significantly. Issues such sample size, cross-sectional versus controlled prospective designs, intervention and specificity of the cognitive test batteries employed, and statistical procedures, e.g. correcting for multiple testing or not, make direct comparisons across studies difficult. Most studies that have been conducted have used women undergoing menopausal transition and more randomized controlled studies are clearly needed in premenopausal women.

Table 1: The table shows an overview of studies investigating the association between estrogens and verbal memory across life phases

Premenopause						
Citation/year	Group	Outcome measures	Sample size	Study design	Intervention	Primary findings
Alhola et al. 2010	Pre- and postmenopause	Verbal memory	n = 8, ET premenopause n = 8, PL premenopause n = 7, ET postmenopause n = 9, PL postmenopause	RPCT / PG / DB	EPT vs PL (6 moths)	Postmenopause ET ↑ verbal memory
Craig et al. 2007	Premenopause (benign leiomyomata uteri)	Verbal memory and brain activity	n = 15, GnRHa n = 15, controls	RCT / PG	GnRHa (8 weeks) as part of treatment	GnRHa ↓ verbal memory retrieval (discrimination) compared to baseline. GnRHa showed different brain activity during encoding
Craig et al. 2008a	Premenopause (benign fibroids)	Verbal memory and brain activity	n = 13	TS	GnRHa (8 weeks) as part of treatment + surgery for benign fibroids	GnRHa ↓ verbal memory. No difference between pre-GnRHa and six months post-GnRHa. Brain activity changed during GnRHa treatment and returned to baseline post-GnRHa
Craig et al. 2008b	Premenopause	Verbal memory and brain activity	n = 16	CS	None (follicular phase)	High estradiol ↑ activity in LIFG in encoding. No effect on verbal memory
Grigorova et al. 2006	Premenopause	Verbal and working memory	n = 25, GnRHa N = 25, controls	CC / TS	GnRHa (4 weeks)	GnRHa ↓ working memory due to decline in estrogen levels. No verbal memory effect
Hatta & Nagaya 2009	Premenopause	Logical verbal memory	n = 27	TS	None (menses vs luteal phase)	No verbal memory effect
Maki et al. 2002	Premenopause	Verbal and visual memory	n = 16	TS	None (early follicular vs midluteal phase)	High estrogen + progesterone ↑ conceptual implicit verbal memory.
Mordecai et al. 2008	Premenopause	Verbal and visual memory	n = 20, BC n = 16, natural cycle	TS	None (early follicular vs midluteal phase)	Natural cycle: no verbal memory effect. BC: Active pill phase ↑ verbal memory.
Owens et al. 2002	Premenopause	Verbal memory	n = 8, GnRHa + ET n = 8, GnRHa n = 10, controls	RCT / PG	GnRHa vs GnRHa + ET	No verbal memory effect
Rosenberg & Park 2002	Premenopause	Verbal working memory	n = 10, non-tricyclic BC n = 8, natural cycle	CC / TS	None (menstrual cycle, 4 phases)	Natural cycle group: High estrogen period ↑ verbal working memory. BC group: No verbal memory effect

Schmidt et al. 2013	Perimenopause	Verbal and visual memory	n = 23, GnRHa + ET/PT n = 11, controls	RCT / CO / DB	GnRHa + ET vs GnRHa + PT	No verbal memory effect
Peri- and postpartum						
Citation/year	Group	Outcome measures	Sample size	Study design	Intervention	Primary findings
Crawley et al. 2003	Perinatal and postpartum	Verbal memory	n = 15 + 25, pregnant n = 14 + 10, controls	CC / TS	None (pregnancy & birth)	No verbal memory effect
Crawley et al. 2008	Perinatal	Verbal, prospective and working memory	n = 25, pregnant (2nd trimester) n = 25, pregnant (3rd trimester) n = 25, controls	CC Data BC	None (pregnancy)	No memory effects
de Groot et al. 2003	Perinatal	Verbal, semantic and working memory.	n = 71, pregnant (14 weeks) n = 57, controls	CC	None (pregnancy)	Pregnancy ↓ verbal memory. No other memory effects.
de Groot et al. 2006	Perinatal and postpartum	Verbal memory	n = 57, pregnant n = 50, controls	CC / TS	None (pregnancy & birth)	Pregnancy ↓ memory encoding and retrieval
Henry & Sherwin 2012	Perinatal and postpartum	Verbal, logical and working memory	n = 55, pregnant n = 21, controls	CC / TS	None (pregnancy & birth)	Pregnancy ↓ verbal memory. No other memory effects
Glynn 2010	Perinatal and postpartum	Verbal, visual and working memory	n = 254, pregnant n = 48, controls	CC / TS	None (pregnancy & birth)	Pregnancy ↓ verbal memory after 29 weeks including 3 months postpartum. No other memory effects
Glynn 2012	Perinatal and postpartum	Cued verbal memory	n = 113, primiparous n = 141, multiparous	TS	None (pregnancy & birth)	Multiparity ↓ cued verbal memory compared to primiparity
Messinis et al. 2010	Postpartum Depression (PPD)	Verbal memory	n = 21, postpartum PPD n = 22, postpartum non-PPD n = 24, controls	CC Data BC	None (postpartum/PPD)	Both postpartum groups ↓ initial memory encoding, but no effect on recall or recognition
Onyper et al. 2010	Perinatal	Verbal, short-term, working and prospective memory	n = 21, pregnant n = 25, controls	CC	None (pregnancy)	No memory effects
Wilson et al. 2011	Perinatal	Verbal, visual and procedural memory	n = 20, pregnant (1st trimester) n = 26, pregnant (3rd trimester) n = 24, controls	CC	None (pregnancy)	Pregnancy ↓ verbal and episodic memory. No other memory effects

Menopausal transition						
Citation/year	Group	Outcome measures	Sample size	Study design	Intervention	Primary findings
Almeida et al. 2006	Late (≥70 years) postmenopause	Verbal and visual memory	n = 39, ET n = 47, PL	RPCT / PG / DB	ET vs PL (20 weeks)	No memory effects
Aveleyra et al. 2005	Early postmenopause	Verbal, visual/nonverbal and working memory	n = 10, ET n = 10, EPT n = 10, controls	RCT / PG Data BC	ET vs ETP	ETP ↑ nonverbal memory. ET ↑ working memory. No effect of HT on verbal memory scores
Berent-Spillson et al. 2012	Pre, peri- and postmenopause	Verbal and visual memory. Brain activity	n = 20, premenopause n = 15, perimenopause n = 32, postmenopause	CS	None (menopausal transition)	No memory effects when corrected for age. Postmenopause group showed different regional brain activity
Binder et al. 2001	Late (≥75 years) postmenopause	Verbal memory	n = 34, ERT n = 18, PL	RPCT / PG / DB	ETP vs PL (9 months)	No verbal memory effect
Drake et al. 2000	Postmenopause	Verbal and visual memory	n = 39	CS	None	High estradiol ↑ verbal memory. Low estradiol ↑ visual memory
Duff & Hampson 2000	Postmenopause	Verbal logical memory and working memory	n = 38, ET n = 23, ETP n = 35, non-HT	CS	ET vs ETP	HT ↑ working memory. No effect on verbal logical memory
Dunkin et al. 2005	Postmenopause	Verbal and nonverbal memory	n = 8, ET n = 9, PL	RPCT / PG / DB	ET vs PL (10 weeks)	No memory effects (BMI ↑ with verbal memory in ET group, but only weakly)
Espeland et al. 2013	Postmenopause (WHI cohort)	Verbal and working memory	n = 609, HT n = 559, PL	RPCT / PG / SB	Previous HT in early postmenopause	No memory effects 7 years after end of HT
Farrag et al. 2002	Postmenopause (surgical)	Cued verbal, logical and visual memory	n = 35, surgical menopause n = 18, controls	CC / TS	Surgical menopause (pre-op + 3 & 6 months follow-up)	Surgery ↓ cued verbal memory at 3 months and all memory tasks at 6 months. Patients with >50% decline in estradiol serum levels showed steeper cognitive decline than <50% group
File et al. 2002	Postmenopause (surgical)	Short-term verbal and long-term visual memory	n = 18, oestradiol implants n = 18, control	CC	Oestradiol implants (~10 years)	Oestradiol implants ↓ long-term visual memory. No verbal memory effect
Fuh et al. 2003	Pre, peri- and postmenopause (KIWI cohort)	Verbal, visual and working memory	n = 77, HT (mixed menopause) n = 694, premenopause n = 323, perimenopause n = 176, postmenopause	CS	None (menopausal transition)	Menopausal status had no effect on verbal memory. HT ↑ in 1 of 2 working memory tasks

Fuh et al. 2006	Pre- and perimenopause (KIWI cohort)	Verbal, visual and working memory	n = 381, premenopause n = 114, perimenopause	TS	None (menopausal transition over ~ 1 year)	Menopausal status / change in menopausal status had no effect on memory
Gorenstein et al. 2011	Postmenopause (surgical)	Verbal memory	n = 27, ET n = 32, PL	RPCT / PG / DB	ET vs PL (168 days)	No verbal memory effect
Greendale et al. 2009	Pre, peri- and postmenopause (SWAN cohort)	Verbal and working memory	n = 2.362	TS	None (menopausal transition in general/with HT (~ 4 years))	Perimenopause showed less improvement in verbal memory compared to premenopause. Postmenopause HT ↓ verbal memory compared to premenopause with no difference for non-HT postmenopause. Prior HT use ↑ baseline scores for all memory tasks compared to women at the same transition stage
Henderson et al. 2003	Pre, peri- and postmenopause (MWMHP cohort)	Episodic verbal memory	n = 326 (23% had received HT)	CS	None (menopausal transition in general/with HT)	Menopausal status had no effect on verbal memory. However HT before onset of menopause ↑ verbal memory compared to later commencement
Herlitz et al. 2007	Pre, peri- and postmenopause (Betula cohort)	Verbal, episodic and semantic memory	n = 129, premenopause n = 58, perimenopause n = 55, postmenopause	CS	None (menopausal transition)	No memory effects
Hogervorst et al. 1999	Postmenopause (Study 2: MAAS cohort)	Verbal memory (study 1). Verbal memory (study 2)	n = 11, HT (study 1) n = 11, controls (study 1) n = 23, HT (study 2) n = 319, non-HT (study 2)	Study 1: CC / TS Study 2: CS	Study 1: HT (1 year) Study 2: HT	Study 1: HT ↑ verbal memory (within group trend). Study 2: No verbal memory effect
Jacobs et al. 1998	Postmenopause	Verbal memory	n = 727 (11% had received ET)	TS	None (menopausal transition in general/with ET (~2½ years))	ET ↑ verbal memory
Joffe et al. 2006	Peri- and early postmenopause	Verbal and visual memory. Brain activity	n = 26, ET n = 26, PL	RPCT / PG / DB	ET vs PL (12 weeks)	ET ↑ fewer perseverence errors in verbal memory. No other memory effects. ET ↑ frontal system activity during verbal and spatial tasks
Kocoska-Maras et al. 2011	Postmenopause	Verbal memory	n = 66, ET n = 67, PL	RPCT / PG / DB	ET vs PL (4 weeks)	No verbal memory effect

Kritz-Silverstein & Barrett-Conner 2002	Postmenopause (surgical) (RBS cohort)	Verbal and visual memory	n = 415, surgical menopause n = 470, natural menopause	CS	Surgical menopause ± HT vs natural menopause ± HT	No memory effects
Krug et al. 2003	Postmenopause	Verbal memory	n = 12	RPCT / CO / DB	ET vs. PL (3 days)	ET ↑ verbal memory for 1 task
Krug et al. 2006	Postmenopause	Cued verbal, logical and working memory	n = 14	RPCT / CO / DB	ET vs. PL (3 days)	ET ↑ Cued and working memory. No other memory effects
LeBlanc et al. 2007	Early postmenopause	Verbal and visual memory	n = 20, low menopausal sympt. n = 17, high menopausal symp. n = 14, ET n = 18, PL	Part 1: CS Part 2: RPCT / PG / DB	None for low/high groups. ET vs PL (8 weeks)	No memory effects
Linzmayer et al. 2001	Postmenopausal syndrome + insomnia	Verbal, numerical and visual memory	n = 17, EPT n = 16, ET n = 16, PL	RPCT / PG / DB	ET vs ETP vs PL (2 months)	ETP ↑ verbal and visual memory. ET ↑ numerical memory
Lokken & Ferraro 2006	Pre- and postmenopause	Verbal, visual and logical memory	n = 12, ET n = 12, premenopause (early) n = 12, premenopause (late) n = 12, postmenopause	CS	None (menopausal transition in general/with ET)	No memory effects
Luetters et al. 2007	Pre, peri- and postmenopause (SWAN cohort)	Episodic verbal and working memory	n = 149, premenopause n = 945, early menopause n = 222, late perimenopause n = 341, postmenopause	CS	None (menopausal transition and FSH and estradiol)	No memory effects
Maki & Resnick 2001	Postmenopause (BLSA cohort)	Verbal, figural and prospective memory. Brain activity	n = 12, HT n = 16, non-HT	TS	HT	HT ↑ collective memory task (borderline) and no memory effect in PET memory tasks. HT ↑ rCBF over time in TL, hip and parahip gyrus
Maki et al. 2001	Postmenopause (BLSA cohort)	Verbal, visual and working memory	n = 103, HT n = 81, non-HT	CS	HT	HT ↑ verbal memory. No other memory effects
Maki et al. 2007	Postmenopause (COGENT cohort)	Verbal memory	n = 89, EPT n = 91, PL	RPCT / PG / DB	EPT vs PL (4 months)	No verbal memory effect
Maki et al. 2011	Postmenopause (MWMHP cohort)	Verbal memory and brain activity	n = 17, ET n = 17, controls	CC	ET	ET ↑ verbal memory and activity in left hip and ↓ activity in bilateral parahip gyrus
Möller et al. 2010	Postmenopause (surgical)	Logical verbal and working memory	n = 44	RPCT / CO / DB	ET + T vs ET + PL (2x24 weeks)	ET+T ↓ logical verbal memory (immediate recall).

Nappi et al. 1999	Postmenopause (surgical)	Verbal memory	n = 27, surgical menopause n = 76, natural menopause	CC	Surgical menopause vs natural menopause	Surgical group ↓ short-term verbal memory. No long-term verbal memory effect
Pefanco et al. 2007	Postmenopause	Verbal memory	n = 31, ET n = 25, PL	RPCT / PG / DB	Low dose ET vs PL (3 years)	No verbal memory effect
Persad et al. 2009	Postmenopause	Verbal memory and brain activity	n = 10	RPCT / CO / DB	ETP vs PL (2x4 weeks)	ET ↑ activity in L middle/superior FC, MFC, dorsal AC, posterior cingulate and L inferior PC. No verbal memory effect
Phillips & Sherwin 1992	Postmenopause (surgical)	Verbal, visual and logical memory	n = 10, ET n = 9, PL	RPCT / PG / DB	ET vs PL (3 months post surgery)	ET ↑ immediate paragraph recall. PL ↓ verbal memory over time. No other memory effects
Polo-Kantola et al. 1998	Postmenopause (surgical)	Verbal and working memory.	n = 62	RPCT / CO / DB	ET vs PL (2x3 months)	No memory effects
Resnick & Maki 2001	Postmenopause (BLSA cohort)	Verbal and figural memory	n = 116, HT n = 172, non-HT	TS	HT	HT ↑ verbal and figurative memory
Resnick et al. 1998	Postmenopause (BLSA cohort)	Verbal, figural and working memory. Brain activity	n = 15, HT n = 15, non-HT	TS	HT	HT ↑ verbal and figurative memory (one-tailed). HT group showed different rCBF in relevant areas during memory tasks
Resnick et al. 2006	Postmenopause (WHIMS cohort)	Verbal, figural and working memory	n = 690, EPT n = 726, PL	RPCT / PG / DB	EPT vs PL (~ 3 years)	Longterm EPT ↓ verbal memory but ↑ figural memory. No other memory effects
Resnick et al. 2009	Postmenopause (surgical) (WHIMS cohort)	Verbal, figural and working memory	n = 434, ET n = 452, PL	RPCT / PG / DB	ET vs PL (~ 3 years)	No memory effects
Ryan et al. 2009	Postmenopause (3C cohort)	Verbal and visual memory	n = 2,169, never-HT n = 487, previous HT n = 474, current HT	TS	None (menopausal transition in general/with HT (4 years))	Current HT use ↑ visual memory at baseline compared to never-HT. No other memory effects between groups or over time
Ryan et al. 2012	Postmenopause (surgical) (MWMHP cohort)	Verbal episodic, visual episodic and semantic memory	n = 148	RPCT / CO / DB	None	High estradiol ↑ semantic memory and semantic memory improvement. No other memory effects

Schaafsma et al. 2010	Pre, peri- and postmenopause	Verbal and visual memory.	n = 22, premenopause n = 48, perimenopause n = 38, postmenopause n = 12, HT	CS Data BC	None (menopausal transition in general/with HT)	No memory effects
Schiff et al. 2005	Postmenopause	Verbal, visual and working memory	n = 19, ET	RPCT / CO	ET vs PL (2x12 weeks)	No memory effects
Shaywitz et al. 1999	Postmenopause	Verbal- and non-verbal working memory. Brain activity	n = 46	RPCT / CO / DB	ET vs PL (2x21 days)	No memory effects. ET showed different fMRI activation during encoding and retrieval of memory
Shaywitz et al. 2003	Postmenopause	Verbal memory	n = 31, ET n = 29, PL	RPCT / PG / DB	ET vs PL	ET ↑ verbal memory
Sherwin 1988	Postmenopause (surgical)	Short-term and longterm verbal memory	n = 10, ET n = 10, ET + AT n = 10, AT n = 10, PL n = 10, controls (hysterecomy)	RPCT / PG / DB	Surgical menopause followed by ET, ET + AT, AT or PL (8 months)	No verbal memory effect of HT postoperative treatment. Oophorectomy patients (i.e. low estradiol and testosterone) in the PL group ↓ short- and longterm verbal memory. No effect on controls
Tierney et al. 2009	Postmenopause (EMS cohort)	Verbal memory	n = 62, ET + NT n = 66, PL	RPCT / PG / DB	ET + NT vs PL (2 years)	No memory effect between ET + NT and PL. Within ET + NT group treatment effect was found for subgroup of women > average in baseline testing but not for ET + NT group < average
Verghese et al. 2000	Postmenopause (surgical) (EAS cohort)	Verbal and working memory	n = 10, ET n = 25, controls	CC	ET	ET ↑ verbal memory on 1 of 2 tasks administered. No other memory effect
Weber et al. 2013	Pre, peri- and postmenopause (RICAM cohort)	Verbal and working memory	n = 34, premenopause (late) n = 28, perimenopause (early) n = 42, perimenopause (late) n = 14, postmenopause (early)	CS	None (menopausal transition)	Postmenopause ↓ verbal memory compared to premenopause. Early perimenopause ↓ verbal and working memory compared to late perimenopause
Wegesin & Stern 2007	Post- and premenopause	Verbal, visual, source and item memory	n = 15, ET n = 16, EPT n = 16, postmenopause n = 16, premenopause	CC	ET vs control & ET vs EPT	General aging effect. ET vs control: No ET effect on verbal or item memory. ET ↑ immediate visual memory but not delayed. ET ↑ source memory. ET vs EPT: ET ↑ source memory.

Wolf et al. 1999	Postmenopause	Verbal, semantic and spatial memory	n = 21, ET n = 17, PL	RPCT / PG / DB	ET vs PL	No memory effects between ET and PL. Within ET group > post treatment median estradiol level ↑ verbal memory
Wolf et al. 2005	Postmenopause (surgical)	Verbal, visual and working memory	n = 12, ET n = 10, EPT n = 13, PL	RPCT / PG / DB	ET vs EPT vs PL (24 weeks)	No memory effects
Wolf & Kirschbaum 2002	Postmenopause	Cued verbal and spatial memory	n = 38	CS	None	High estradiol and testosterone ↑ cued verbal memory. No other memory effect
Wroolie et al. 2011	Postmenopause (high-risk for AD)	Verbal, visual and working memory	n = 43, ET (17 β-E) n = 25, ET (CEE)	CS	ET: 17 β-E vs CEE (>1 year)	Verbal memory ↑ for 17 β-E group compared to CEE group
Yaffe et al. 2006	Postmenopause	Verbal, visuospatial and semantic memory	n = 208, ET n = 209, controls	RPCT / PG / DB	Low dose ET vs PL (2 years)	No memory effects
Yonker et al. 2006	Postmenopause (Betula cohort)	Episodic (verbal and visual) and semantic memory	n = 43, ET n = 65, controls	CC	ET	ET ↑ episodic verbal and visual memory. No effect on semantic memory
Zhou et al. 2011	Postmenopause (surgical)	Verbal memory	n = 50, surgical menopause n = 50, controls	CC	None (unilateral oophorectomy)	Unilateral oophorectomy ↓ verbal memory

Notes for Table 1: Study design: CC = case-controlled study, CO = crossover, CS = cross-sectional study, DB = double-blind, PG = parallel-group, RCT = randomized controlled trial, RPCT = randomized-placebo controlled trial, SB = single-blind, TS = time series study (prospective), BC = Bonferroni correction used. Therapy and hormones: AD = Alzheimer's disease, AT = androgen therapy, BC = birth control, CEE = conjugated equine estrogen, EPT = estrogen + progesterone therapy, ET = estrogen (replacement) therapy, FSH = follicle-stimulating hormone, GnRH_a = gonadotropin-releasing hormone agonist, HT = hormone therapy (mixed ET and EPT), NL = norethindrone therapy, PL = placebo, PT = progesterone therapy, T = testosterone. Brain regions: AC = anterior cingulate, FC = frontal cortex, Hip = hippocampus, Parahip gyrus = parahippocampal gyrus, L = left, LIFG = left inferior frontal gyrus, MFC = medial frontal cortex, PC = parietal cortex, TL = temporal lobe, rCBF = regional cerebral blood flow. Studies: 3C = Three City Study, BLSA = Baltimore Longitudinal Study of Aging, COGENT = Cognitive Complaint in Early Menopause Study, EAS = Einstein Aging Study, EMS = The Estrogen Memory Study, KIWI = Kinmen Women-Health Investigation, MAAS = Maastricht Aging Study, MWMHP = Melbourne Women's Midlife Health Project, RBS = Racho Bernardo Study, RICAM = Rochester Investigation of Cognition Across Menopause, SWAN = Study of Women's Health Across the Nation, WHI = Woman's Health Initiative, WHIMS = Women's Health Initiative Memory Study. Surgical postmenopause includes oophorectomy and/or hysterectomy.

Importantly, ovarian hormones modulate synaptic neurotransmission through non-genomic mechanisms, where they alter synaptic function and excitability by acting pre- and postsynaptically on a number of neurotransmitters and neuropeptides (Paul and Purdy, 1992). Their molecular targets in brain regions underlying emotion and memory may therefore represent a potential mechanism through which they are implicated in increasing risk for major depression (McEwen, 2002, McEwen, 2001). Serotonin (5-HT) is one such molecular target affected by estradiol and known to be critically involved in the neurobiology of memory and major depression, where it is the main target for antidepressant treatment (Morilak and Frazer, 2004).

Serotonin (5-HT) neurotransmission

A vast amount of scientific effort has been put into the study of brain serotonin (5-hydroxytryptamine = 5-HT). 5-HT cannot be transported across the blood brain barrier and has to be synthesized inside the central nervous system from its precursor tryptophan; an essential amino acid available from diet (Silber and Schmitt, 2010). 5-HT is a neurotransmitter that is involved in the modulation of sleep, eating behaviours, stress, mood and cognitive processes, e.g. consolidation of memory (Mendelsohn *et al.*, 2009). 5-HT agents have also shown efficacy in treating multiple types of neuropsychiatric conditions such as major depression, anxiety disorders, chronic pain, sleep disturbances, and obsessive-compulsive disorder (Müller and Jacobs, 2010). However, the pharmacology of 5-HT is complicated and includes both pre- and postsynaptic sites of action.

Seven major classes of 5-HT receptors (5-HT₁₋₇) have been identified, and for some of these (e. g. 5-HT₂) subtypes such as 5-HT_{2A}, 5-HT_{2B}, and 5-HT_{2C} exist. Most 5-HT receptors are located post-synaptically on neurons and vascular elements and except from 5-HT₃ they are all G-protein-coupled. Only the 5-HT_{1A} receptors in raphe nuclei are located pre-synaptically and have an auto-regulatory function through negative feedback on 5-HT release. Besides the seven major classes of serotonin receptors, a pre-synaptic located protein; the 5-HT transporter (5-HTT) is responsible for the reuptake of 5-HT, including clearing the synapse of 5-HT, recycling of 5-HT, terminating 5-HT signalling and preparing for a new signal (Olivier, 2015). 5-HT neurons originate from the raphe nuclei at brain stem levels and gives rise to descending and ascending projections to the entire brain, where the regional distributions of 5-HT receptors are highly specific. These pre- and postsynaptic 5-HT action sites are

important biomarkers of the 5-HT system and especially the pre-synaptically located 5-HTT is in a key position to modulate 5-HT tonus as evidenced by the antidepressant effects of selective serotonin reuptake inhibitors (SSRIs) (Keller, 2000). Two biomarkers of the 5-HT system are used in this thesis; the 5-HT₄ receptor and the 5-HTT.

The 5-HT₄ receptor is expressed with high density in the basal ganglia and in limbic regions such as hippocampus and amygdala and with lower density in cortical regions (Haahr *et al.*, 2013, Varnas *et al.*, 2003). We have recently shown how the 5-HT₄ receptor represents a biomarker inversely related to 5-HT tonus (Haahr *et al.*, 2014). The 5-HTT is expressed with high density in the midbrain, thalamus, putamen, and caudatus and with lower density in the anterior cingulate and frontal cortex (Varnas *et al.*, 2004). Furthermore, the 5-HTT is located on cell bodies and terminals of 5-HT neurons and represents a biomarker of 5-HT innervation (Blakely *et al.*, 1994).

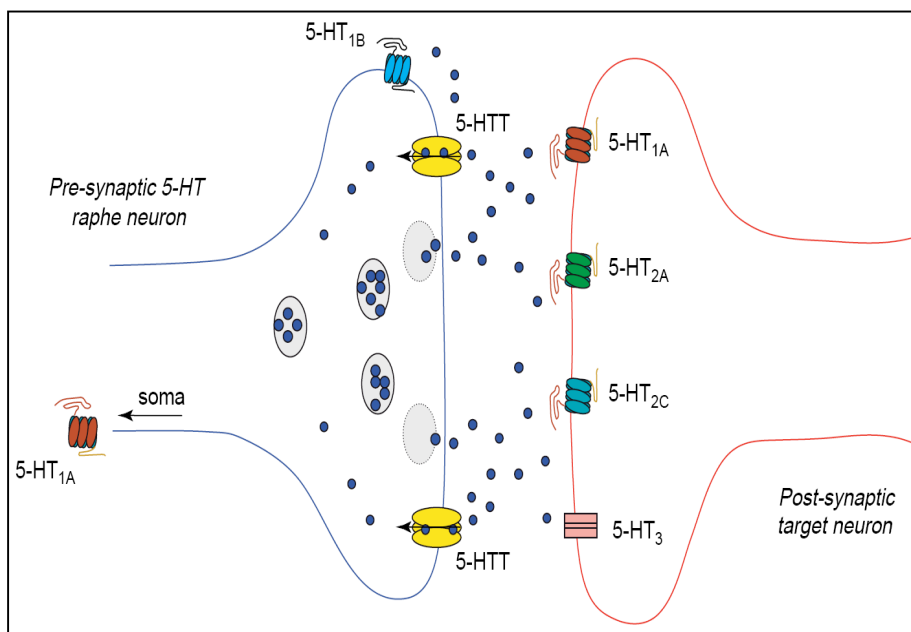

Figure 4: The figure shows a 5-HT synapse with pre – and post-synaptic target sites

Positron Emission Tomography (PET) is an advanced imaging technique that allows for specifying *in vivo* physiological, biochemical, and pharmacological 5-HT processes in the brain, although suitable radiotracers for evaluating many 5-HT receptor sites *in vivo* are not yet available. PET imaging is conducted by using a positron-emitting radioisotope (tracer), which has been labeled on to a biologically active chemical structure (precursor) that binds to the molecular target site of interest in the brain. The PET technology then detects pairs of

gamma rays emitted indirectly by the tracer as the radioisotope undergoes positron emission decay. The carbon labeled PET tracers; [^{11}C]SB207145 and [^{11}C]DASB were used to *in vivo* image the 5-HT₄ receptor and the 5-HTT in the included studies in the thesis. While the [^{11}C]DASB radiotracer has been available since year 2000 (Houle *et al.*, 2000), the [^{11}C]SB207145 radiotracer was only recently developed (Gee *et al.*, 2008).

Interaction between estrogenic and 5-HT systems

Crosstalk between estrogenic (mostly estradiol) and 5-HT systems is evidenced by a number of preclinical and clinical studies (Bethea *et al.*, 2002, Frokjaer *et al.*, 2010, Lokuge *et al.*, 2011). In animal studies administration of estrogen may enhance 5-HT synthesis and thereby increase 5-HT tone (Bethea *et al.*, 2000), decrease 5-HT degradation enzymes (Gundlah *et al.*, 2002), and decrease inhibitory feedback to 5-HT neurons (Henderson and Bethea, 2008, Lu and Bethea, 2002). In humans, longer-term estrogen (combined with testosterone) treatment decreased 5-HTT binding in cortical regions in surgically postmenopausal women (Jovanovic *et al.*, 2015). In a rat model of pregnancy- to postpartum transition, estradiol treatment increased in 5-HTT gene expression (Suda *et al.*, 2008).

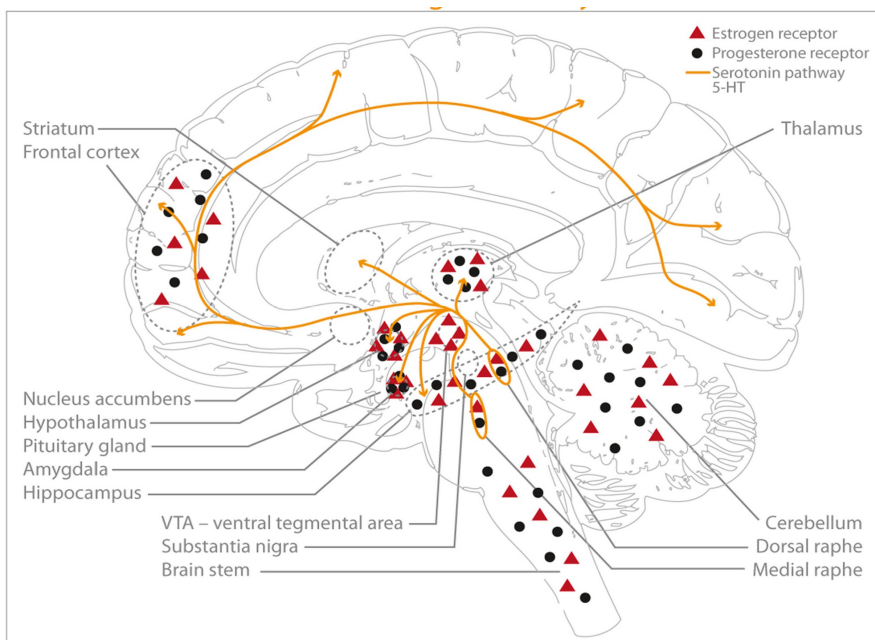

Figure 5: The figure shows a schematic representation of the human 5-HT system and the partially overlapping schematic display of estrogen receptor distribution. Adapted from Barth *et al.*, 2015

Preliminary behavioral evidence in menopausal women have shown serotonin-mediated influence of ovarian hormones on brain activity during emotional processing (Epperson *et al.*,

2012) and protective effects of estrogen treatment on acute tryptophan depletion (ATD)-induced memory impairment (Amin *et al.*, 2006), suggesting that estrogens may counteract the adverse effects of compromised 5-HT signaling on affective and mnemonic processes. In women with premenstrual syndrome, behavioral symptoms can be alleviated with SSRI treatment (Dimmock *et al.*, 2000), suggesting a coupling between premenstrual phase, i.e. low levels of estradiol, and 5-HTT regulation of the 5-HT system on adverse symptoms. In the cohort of premenopausal asymptomatic women treated with a GnRH agonist presented in the thesis (study 3), an interaction effect between drop in estradiol and upregulation of 5-HTT binding was found on Hamilton Depression Rating scale, suggesting that a controlled biphasic estradiol fluctuation may act in concert with compromised 5-HT signaling as indexed by an up-regulation of 5-HTT binding to produce a depressive response (Frokjaer *et al.*, 2015).

The following will describe the three included studies in this thesis and present the obtained main results. This will be followed by a discussion of main findings, a conclusion, and an outline of future research perspectives.

AIMS AND HYPOTHESES

The overall aim of the studies included in this thesis was to examine sex-steroid hormone fluctuations and pre- and post-synaptic 5-HT neurotransmission in relation to verbal affective memory recall, simple reaction time, and mental distress including serial daily mood reports in healthy volunteers and sub-fertile women undergoing ART. This task was undertaken by investigating these factors in response to pharmacological challenges with GnRHa and in association with a PET-marker of endogenous 5-HT signalling. The following briefly describes the specific aims and hypotheses of the included studies.

Study 1 (Paper 1)

In this study, we aimed to examine the effects of undergoing GnRHa versus GnRH antagonist protocol for assisted reproductive technology (ART) on measures of mental distress and mood fluctuations in women. We also aimed to investigate the role of personality trait Neuroticism. We therefore tested the following hypotheses: (1) Women in GnRHa protocol exhibit increased levels of mental distress compared to women in GnRH antagonist protocol; (2) Mood fluctuations are more pronounced in GnRHa protocol compared to GnRH antagonist protocol; and (3) Neuroticism interacts with protocols and independently affects levels of mental distress and mood fluctuations.

Study 2 (paper 2)

In this study, we aimed to examine the association between 5-HT₄R binding, as a marker of 5-HT tonus, and performance on the Danish Verbal Affective Memory Test-24 (VAMT-24) in healthy men and women. Based on previous findings from our research group of a negative association between 5HT₄R binding and episodic memory, we therefore hypothesized: (1) A negative association between 5HT₄R binding and total recall of words; and (2) 5-HT₄R related differences in recall of neutral, positive, and negative words.

Study 3 (paper 3)

In this study, we aimed to examine the direct effects of GnRHa intervention (compared to placebo) and effects mediated by changes in neocortical 5-HTT binding on verbal affective memory recall (VAMT-24), simple reaction time and self-reported measures of mental

distress including daily mood profiles. We therefore tested the following hypotheses: (1) Women undergoing hormone manipulation exhibit decreased total verbal memory recall including increased recall for negative relative to positive words and increased mean reaction time latency compared to placebo; (2) Women also report increased levels of self-reported mental distress and more pronounced mood fluctuations during manipulation compared to placebo; and (3) Such effects are partly mediated by changes in neocortical 5-HTT binding.

METHODS AND DESIGNS

Participants

For study 2 and 3, a total of 85 healthy participants over 18 years of age were recruited through Internet and newspaper advertisement with no overlap between the samples. Eligible participants were screened for current and previous psychiatric symptoms, relevant medical history, alcohol, tobacco, illegal drug use, and abnormal blood tests. They also underwent a neurological examination by a trained clinician. Exclusion criteria for the studies were significant medical history, which included psychiatric disorders, head trauma, a family history of psychiatric disorders, drug and alcohol abuse, and current or previous use of psychoactive drugs. Additional exclusion criteria for study 3 were premenstrual dysphoric disorder (according to DSM-IV criteria) and abnormal gynaecological examination, including ultrasound imaging of the uterus and ovaries, performed by a trained clinician.

For study 1, a total of 83 women undergoing their first ART-cycle were included at the Department of Endocrinology, Hvidovre Hospital. Exclusion criteria were; prior *in vitro* fertilisation treatment, uterine anomalies, testicular sperm aspiration needed, allergy to the ingredients used in the pharmacological treatment, reduced kidney or liver function, women > 40 years of age, prior or current use of antidepressant medication.

The Ethics Committee for the Capital Region of Denmark approved all studies and study 1 was also registered as a clinical trial (EudraCT - 2008-005452-24). All participants signed an informed consent after receiving oral and written information about the studies in compliance with the World Medical Association Declaration of Helsinki.

In study 2 and 3, educational scores were rated on a 5-point Likert scale; 1 (no vocational degree), 2 (<2 years of vocational education), 3 (2—4 years of vocational secondary education), 4 (2—4 years of academic education including a prior high school degree) to 5 (>4 years of academic education including a prior high school degree). In study 3, a total score was used reflecting the number of years spend in school.

Demographics in study 1 (paper 1)

- 83 women undergoing their first ART-cycle with GnRH antagonist or GnRHa protocol, tested with self-reported measures of mental distress
- Mean age: 33.5 ± 4.8 years (range 22 – 40 years)
- Mean BMI: 25.0 ± 5.1 kg/m² (range 15.5 – 42.7 kg/m²)

Demographics in study 2 (paper 2)

- 24 healthy participants (3 women) scanned with the [¹¹C]SB207145 tracer to image the 5-HT₄ receptor and tested with the VAMT-24
- Mean age: 26.7 ± 6.4 years (range 20 – 45 years)
- Mean BMI: 23.6 ± 3.0 kg/m² (range 19 – 31 kg/m²)
- Mean educational attainment: 4.0 ± 1.3 (range 1 – 5 educational points)

Demographics in study 3 (paper 3)

- 61 healthy women undergoing sex-steroid hormone manipulation with GnRHa or placebo, scanned with the [¹¹C]DASB tracer to image the 5-HTT and tested with VAMT-24, a simple reaction time test, and self-reported measures of mental distress
- Mean age: 24.3 ± 4.8 years (range 18 – 37 years)
- Mean BMI: 23.3 ± 3.1 kg/m² (range 17 – 33 kg/m²)
- Mean educational attainment in years: 15.9 ± 1.59 (range 11 – 17 years)

Study designs

Study 1 was established as an add-on to a larger ongoing Danish clinical randomised trial evaluating the outcome of two commonly used ART-protocols in the period 2010-2012. The sub-fertile women were consecutively randomised 1:1 to GnRH antagonist or GnRHa protocol by a project nurse at Hvidovre hospital, stratified by age (≤ 36 years and > 36 years) and the need for intra-cytoplasmic sperm injection or general *in vitro* fertilisation. Blinding in this study was not possible due to the nature of treatment; however, the clinicians responsible for the treatment were not otherwise involved in the collection or analysis of data.

Study 3 was conducted as a randomized controlled double-blinded study, where healthy premenopausal women were randomised to intervention with GnRHa or placebo.

Study 2 was conducted as a cross-sectional study based on extracted data from a large multimodality database containing data from healthy volunteers acquired within the

Lundbeck Foundation Center for Integrated Molecular Brain Imaging (CIMBI) (Knudsen *et al.*, 2015). I conducted or supervised all neuropsychological testing across the included studies in this thesis with much appreciated help from my co-author Liv Vadskjær Hjordt (partly in study 2).

Intervention and blinding in study 1 and 3

The study population in study 1 is a subgroup of a larger ongoing Danish clinical randomised trial evaluating treatment outcome of two commonly used ART-protocols for sub-fertile women. When a woman undergoes ART treatment, where eggs are artificially fertilised in test tubes, an amount of 8-10 matured eggs is required instead of the usual 1 matured egg as during a natural menstrual cycle. The procedure used to achieve this is called controlled ovarian stimulation. The two ART-protocols differ in how it is avoided that an uncontrollable amount of eggs are matured during the stimulation procedure. In one of the protocols, a GnRH antagonist is administered when the ovarian stimulation has reached a point, in which there is a risk of uncontrollable egg maturation. In the other protocol, pre-treatment with a GnRHa is administered to avoid uncontrollable egg maturation during stimulation.

Women in the GnRH antagonist protocol received daily injections with the recombinant follicle-stimulating hormone (rFSH) analogue, Puregon®, to initiate ovarian stimulation (150 i.e. ≤ 36 years, and 225 i.e. > 36 years, respectively) starting at cycle day 2-3. After five days of stimulation treatment, the women received additional daily subcutaneous injections with the GnRH antagonist, Orgalutran® (1 x 0.25 mg.). Women in the GnRHa protocol received daily nasal administration of the GnRHa, Syranela®, to suppress ovarian hormone production (200 mg. x 3 daily) starting at cycle day 21. After fourteen days of GnRHa administration (cycle day 35), the women received additional daily injections with Puregon® (150 i.e. ≤ 36 years and 225 i.e. > 36 years, respectively). Nasal administration of Syranela® was continued (200 mg. x 2 daily) until the day of oocyte pick-up. In both protocols ovulation induction was induced by subcutaneous injection with Ovitrelle® (6500 i.e.), when the three largest ovarian follicles had a diameter ≥ 17 mm. Oocyte retrieval was performed 36-38 hours later.

In study 3, the participating healthy women received an implant with the GnRHa, goserelin, 3.6 mg, or a saline injection, in a natural cycle during the midluteal phase, by a gynaecologist who was not involved in any subsequent data handling. The women reported back to a blinded research assistant upon bleeding, and were called back for the post-

interventional follow-up 14-21 days after implant. Of initially 63 women recruited, one woman did not receive intervention due to anovulation and one became pregnant and could not complete follow-up. Consequently, 61 women were included in the final analyses.

Developing a Danish verbal affective memory test

Currently no validated Danish test of affective words exists and we therefore wanted to develop a Danish verbal affective memory test, which was visually presented and computer-based. First, we designed an initial word evaluation project to ensure face-validity of the perceived valences of the affective and neutral words that were to be included in the test. Via posters at Copenhagen University and word of mouth we invited participants for an unpaid word evaluation project and screened a total of 103 volunteering participants.

Participants who reported mental illnesses ($n = 13$) and drug use >24 times/year ($n = 3$) were excluded, thus, our sample comprised 87 healthy individuals (67 women) with a mean age of 37 ± 15 years (range 19 – 65). A large majority of the sample scored high on educational attainment. No differences were observed between men and women with regards to age or educational attainment (all p -values > 0.19). Overall alcohol consumption was within normal range and 88% used no medication, while 12% took medication for asthma or allergy, metabolism regulation, or birth control. We constructed an online rating questionnaire that the participants accessed to rate 210 monosyllabic Danish words by clicking on a 7-point line from 1 (very positive) over 4 (neutral) to 7 (very negative).

Based on the obtained results, we selected only words that had a 95% agreement on perceived valence across raters. Thus, if 95 % of the participants rated a word from 1 – 3, we considered it eligible as a positive word, if rated from 3 – 5, we considered it a neutral word, and if rated from 5 – 7, we considered it a negative word. Words with mean ratings close to 1.0 (positive), 4.0 (neutral), or 7.0 (negative) with a corrected mean item-total correlation $r \geq 0.30$ within each valence were preferred and the internal consistency of ratings within each valence was defined as Cronbach's $\alpha \geq 0.70$ (Cronbach, 1951). From a linguistic research database of Danish texts (<http://ordnet.dk/korpusdk>), we obtained word counts of the included words to ensure that the frequency of use did not differ between valences.

From this work, we constructed two targets lists (A-24 and B-24) and an interference list (I-24), each consisting of 8 positive (4 adjectives, 4 nouns), 8 negative (4 adjectives, 4 nouns), and 8 neutral nouns. We matched list A-24 and B-24 semantically (e.g. A-24: Mord [murder],

B-24: Drab [murder]; A-24: Pest [plague], B-24: Svulst [tumor]; A-24: Smil [smile]; B-24: Grin [laugh]; A-24: Glad [happy], B-24: Fryd [joy]) and tested that they did not differ in overall frequency of word use (all p-values > 0.7). After validating this test set-up (Jensen *et al.*, In press), we also constructed a single target list (A-26) consisting of 10 positive nouns, 10 negative nouns, and 6 neutral nouns, based on the same pool of words. We named the two versions of the test “Verbal Affective Memory Test-24” (VAMT-24) and “Verbal Affective Memory Test-26” (VAMT-26), respectively. VAMT-24 was used in study 2 and 3. Data has currently been collected for the VAMT-26 across studies of healthy participants and violent inmates, which remains to be validated in a follow-up study testing its psychometric properties.

MEASURES

Verbal Affective Memory Test-24 (VAMT-24)

The VAMT-24 is a computerized test of approximately 25 minutes, which includes three conditions: 1) Learning and Immediate recall (IMM), in which participants view 24 words on a computer screen (list A-24 at baseline and list B-24 at follow-up) and are instructed to recall as many as possible. This procedure is repeated five times; 2) Short-term recall (STM), in which participants view an interference list of 24 words on the computer screen (I-24) and are instructed to recall list A-24 (at baseline) or list B-24 (at follow-up); and 3) Long-term recall (LTM), in which participants are asked to do a surprise recall of list A-24 (at baseline) or list B-24 (at follow-up) after a period of 30 minutes. Word lists display a fixed, counterbalanced order of words with respect to valence: 123/321/231/132/312/213/132/213 (1 = positive, 2 = negative, 3 = neutral). The first and second words are positive and negative respectively, while the last is neutral to decrease test-inherent affective biases due to primacy and recency effects. Words with similar first letters are separated by at least four other words. Each word trial displays a fixation cross (750ms) and a word (750ms) in black (font = Times, size = 40) on a grey background. The screen is viewed from a distance of \approx 60cm. VAMT-24 was programmed in Eprime 2.0 Professional (Psychology Software Tools, US).

In study 2 and 3, the recall scores were highly correlated within each word category (positive word recall, all r s > 0.68, negative word recall, all r s > 0.61, and neutral word recall,

all $r_s > 0.64$). Therefore, we computed a composite memory score for each word category. The computed composite scores for each word category (positive: $Total_{Pos}$, negative: $Total_{Neg}$, and neutral: $Total_{Neu}$ words) were defined as: $Total_{cat} = IMM_{cat} + STM_{cat} + LTM_{cat}$, where IMM_{cat} , STM_{cat} and LTM_{cat} , are immediate, short-term and long-term VAMT scores respectively, each for a given category.

The Simple Reaction Time test (SRT)

The SRT is a computerized test of approximately 6-10 minutes and provides a measure of simple reaction time by delivery of a known stimulus to a known location to elicit a known response. The participants are shown a white square on the screen with a variable interval and are instructed to press a button as soon as they see it. The mean reaction time latency (in msec) is the main outcome of the test.

Personality assessment

All the women in study 1 and 3 completed the Danish version (Skovdahl Hansen *et al.*, 2003) of the NEO PI-R in order to index the personality domain Neuroticism (Costa and McCrae, 1992). The NEO PI-R is a self-report inventory, which measures five major domains of personality; Neuroticism, Extraversion, Openness, Agreeableness, and Conscientiousness. For each domain adding the scores for six sub-facets or concrete traits derives a domain score. For the purposes of study 1 and 3 only the Neuroticism domain was used, as high scores on this domain is a known risk marker of major depression (Kendler *et al.*, 1993, Fanous *et al.*, 2007), schizophrenia (Van Os and Jones, 2001), anxiety (Clark *et al.*, 1994), dementia (Low *et al.*, 2013) and bipolar disorder (Jylhä *et al.*, 2010).

The Neuroticism domain comprises 48 items (e.g. “I am not a worrier” or “I often get angry at the way people treat me”) rated on a 5-point Likert scale from 0 (strongly disagree) to 4 (strongly agree). The constituent sub-facets of Neuroticism are: Anxiety, angry hostility, depression, self-consciousness, impulsiveness, and vulnerability. Individuals who score high on Neuroticism tend to exhibit higher general susceptibility to stress, higher levels of free floating anxiety, and to interpret the world around them as threatening and frustrating, which make them more prone to experience anxiety, anger, guilt, stress, or sadness. In study 1 and 3, where NEO PI-R was applied, internal consistency coefficients (Cronbach’s alpha, α) for the

Neuroticism domain were high, $\alpha_s \geq 0.90$.

Table 2: The NEO PI-R domains and facets

Domains	Neuroticism	Extraversion	Openness	Agreeableness	Conscientiousness
Facets	Anxiety	Warmth	Fantasy	Trust	Competence
	Angry Hostility	Gregariousness	Aesthetics	Straightforwardness	Order
	Depression	Assertiveness	Feelings	Altruism	Dutifulness
	Self-consciousness	Activity	Actions	Compliance	Achievement-
	Impulsiveness	Excitement-	Ideas	Modesty	Striving
	Vulnerability	Seeking	Values	Tender-Mindedness	Self-discipline
		Positive Emotions			Deliberation

Mental distress and daily mood

In study 1 and 3 measures of mental distress and mood were obtained as main outcomes. In order to obtain a broad characterization of self-reported levels of mental distress we compiled a package of four Danish back-translated questionnaires assessing: Mood disturbances (Profile Of Mood States, POMS), perceived stress (Perceived Stress Scale, PSS), global symptom distress (Symptom CheckList 92-Revised, SCL 92-R), and depressive symptoms (Major Depression Inventory, MDI) (see below for details). Thus, we use “mental distress” as an umbrella term covering aspects such as mood and depressive symptoms, general symptomatic state (including symptom clusters such as obsessive-compulsive, psychoticism, and somatization), and levels of perceived stress.

The Profile of Mood States (POMS)

The POMS is a psychological rating scale used to assess transient, distinct mood states (McNair and Lorr, 1992). It consists of six factors and a total score of mood disturbance rated by 65 adjectives (e.g. “Furious”, “Hopeless” and “Carefree”) on a 5-point Likert scale from 1 (not at all) to 5 (extremely) - based on the recollection of the last 24 hours. For the purpose of this study the total mood disturbance score (TMD) was used. Internal consistency coefficients for the TMD in study 1 and 3 were high, $\alpha_s \geq 0.84$.

The Perceived Stress Scale (PSS)

The PSS is a rating scale, which provides a score of how unpredictable, uncontrollable and overloaded life is perceived (Cohen *et al.*, 1983). It consists of 10 stress-related items (e.g. “How often have you felt that you were unable to control the important things in your life?”) rated on a Likert scale from 1 (never) to 5 (very often) based on the recollection of the last two weeks. Internal consistency coefficients for the PSS in study 1 and 3 were high, $\alpha \geq 0.81$.

The Symptom Checklist-92-Revised (SCL-92-R)

The Danish version of the SCL-92-R (Olsen *et al.*, 2006) was used to assess severity of mental distress. The SCL-92-R comprises 92 items (e.g. “Difficulty making decision” or “Feeling afraid to go out of your house alone”) rated on a 5-point Likert scale of distress from 0 (none) to 4 (extreme). Nine primary symptom scales and three global indices of distress are derived. For the purpose of this study the Global Severity Index (GSI) was used. Internal consistency coefficients for the GSI in study 1 and 3 were high, $\alpha \geq 0.91$.

The Major Depression Inventory (MDI)

The MDI is a rating scale of depressive symptoms according to DSM-IV and ICD-10 diagnostic criteria (Bech *et al.*, 2001). It comprises 10 items (e.g. “Have you felt very restless?” or “Have you suffered from reduced appetite?”) rated on a Likert scale from 0 (never) to 5 (all the time) based on the recollection of the last two weeks. Internal consistency coefficients for the MDI in study 1 and 3 were acceptable, $\alpha \geq 0.63$.

Due to the amount of self-reported data and to reduce manual errors, all the applied questionnaires (including NEO PI-R) were created in electronic versions and completed by the participants using a token-based, encrypted secure online survey system (<https://survey.nru.dk/>). Here a pre-programmed algorithm automatically scored them before they were extracted (Knudsen *et al.*, 2015). For the GnRH antagonist and GnRHa interventions in study 1 and 3, we wanted to monitor the women’s daily mood during hormone treatment to study fluctuations in response to treatment. Thus, we added all daily questionnaires to a token-based link, which the women could access from home.

Positron Emission Tomography (PET) and Magnetic Resonance Imaging (MRI)

For imaging of the 5-HT₄ receptor (study 2), a 120 min dynamic PET acquisition was initiated immediately after bolus injection of the radiotracer [¹¹C]SB207145. For imaging of the 5-HTT (study 3), a 90 min dynamic PET acquisition was initiated immediately after bolus injection of the radiotracer [¹¹C]DASB at baseline and follow-up. The scans were reconstructed using the iterative PSF reconstruction with attenuation map improvements (Comtat *et al.*, 2008, Hong *et al.*, 2007, Sureau *et al.*, 2008). MRI was conducted on a 3T Siemens Magnetom Trio scanner (Erlangen, Germany). High-resolution 3D T1-weighted and 2D T2-weighted sequences were acquired and corrected for spatial distortions and non-uniformity. The T1-weighted brain MRIs were segmented into gray matter, white matter, and cerebrospinal fluid using SPM8 (Wellcome Department of Cognitive Neurology, London, UK) and each voxel was assigned to the tissue class with the highest probability and this segmentation was subsequently used for delineation of the region of interest. The T2 weighted images served for brain masking purposes.

Pvelab was used to automatically delineate volumes of interest from the participant's structural MRI scan and time-activity curves within each region were determined as described earlier (Svarer *et al.*, 2005). The binding potentials of [¹¹C]SB207145 and [¹¹C]DASB were modeled with the simplified reference tissue model using PMOD (PMOD, Zurich, Switzerland) with cerebellum as a reference region (Marner *et al.*, 2009). The binding potential represents a composite measure of receptor density and affinity (Innis *et al.*, 2007).

A volume-weighted sum of orbitofrontal cortex, medial inferior frontal gyrus and superior frontal gyrus was used to delineate a frontal cortex volume of interest (study 2) and orbito frontal cortex, medial inferior frontal gyrus, medial inferior temporal gyrus, superior frontal gyrus, parietal cortex, occipital cortex, superior temporal gyrus, and sensory motor cortex to delineate a neocortex volume of interest (study 3).

In study 2, a total of four regions were included in our model: Frontal cortex, amygdala, hippocampus and anterior cingulate. These regions are known to be involved in memory and emotion, and are commonly referred to as the brain's emotional circuitry (Eglen *et al.*, 1995, Elliott *et al.*, 2002). Based on the findings reported in Frokjaer *et al.* (2015), we used neocortex in study 3 as our volume of interest to probe 5-HTT-mediated effects of GnRHa intervention on VAMT-24, SRT, and self-reported levels of mental distress.

Estradiol sampling

In study 1, venous blood was drawn from all women at baseline and during treatment. Plasma was kept at a temperature between 2 - 8°C until analysed on a routine basis at the hospital laboratory after a maximum of 7 days. Estradiol concentrations were determined by Electrochemiluminiscense Immunoassays (ECLIA) method on a Cobas E601 Immunology Analyzer (Roche, Mannheim, Germany) with a lower detection limit of 0.02 nmol/L.

In study 3, serum collected on the day of the PET scan was delivered immediately to the hospital laboratory and kept at 5°C until assayed within 24 hours. Estradiol concentrations were determined by the Electrochemiluminescence Immunoassay (ECLIA) method on Modular Analytics Serum Work Area equipment (Roche, Mannheim, Germany) with a detection range of 0.04 to 78.9 nmol/L.

Statistical analyses

Demographic data were analysed using Student's t tests or Mann Whitney's U tests for continuous data and Chi-square tests (χ^2) for categorical data. In study 1, repeated measures analysis of variance or Friedman's test was used to examine ART-induced changes in mental distress and plasma levels of estradiol. For interaction analyses between Neuroticism and GnRHa intervention in study 1 and 3, we used either a general linear model (study 1) or a multigroup analysis (study 3). Internal consistency was measured with Cronbach's alpha in study 1 and 3. Pearson's or Spearman's correlation coefficients and Wilcoxon or Mann-Whitney U non-parametric tests for paired and unpaired observations were used when relevant throughout the studies.

For the more advanced statistical analyses in study 2 and 3, we employed a structural equation modeling (SEM) approach. SEM refers to a class of statistical methods designed to test a conceptual or theoretical model, including confirmatory factor analysis, path analysis, and latent growth models (Kaplan, 2008). A major advantage of this approach is its ability to handle inter-correlated data and to isolate observational error from latent variable measurements.

In study 2, we constructed a measurement model defining two latent variables; one predicting the inter-correlation between VAMT-24 word categories and one predicting the inter-correlation between regional 5-HT₄ receptor binding in frontal cortex, amygdala, hippocampus and anterior cingulate cortex. The two latent variables were linked through a

structural regression model testing the association between them using a system of simultaneous regression equations.

In study 3, our primary model type tested direct effects of intervention and effects mediated by changes in neocortical 5-HTT binding on either a LV capturing shared correlation between related outcome measures or a single outcome measure after intervention. In total, this model type was used to predict four outcomes in four separate models: (1) a LV predicting the inter-correlation between VAMT-24 word categories, (2) a LV capturing predicting the inter-correlation between mental distress scores, (3) PSS, and (4) SRT. PSS was initially included in our LV_{md} but model evaluation indicated that it did not load well onto the LV_{md} . Thus, it was treated as a single outcome measure and analyzed separately. Figure 1 shows a schematic model of the SEM used in study 3.

To test for differential effects of intervention status or 5-HT₄ receptor binding across word categories in study 2 and 3, a Wald test was used. Overall model fit was determined by comparison to a saturated model and good fit was observed for all models reported in the studies, i.e., $p > 0.05$ in a Likelihood Ratio test of final versus saturated model.

Intervention effects on serial daily reports of TMD were examined using a general linear model including the standard deviation of serial daily reports of TMD (study 1) or by using a mixed model including a third degree polynomial modeling of serial daily reports of TMD (study 3).

Analyses were carried out in SPSS (version 20.0), R (version 3.0.1) (Team, 2013), or SAS (version 9.4) with alpha set at 0.05.

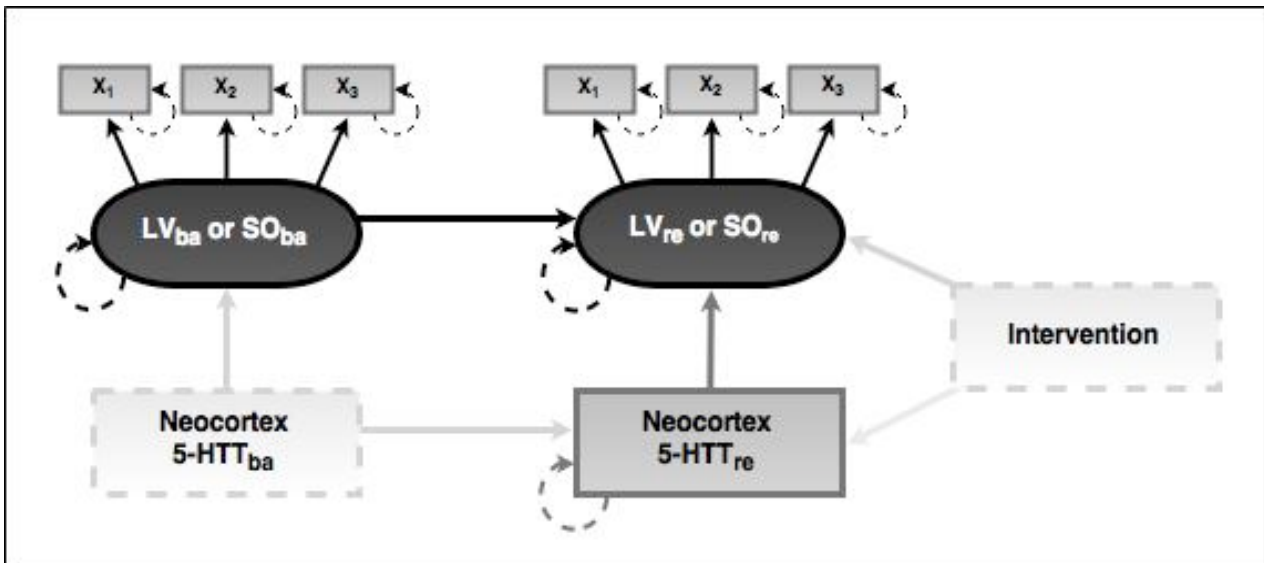

Figure 6: The figure shows a schematic overview of the applied structural equation model in study 3 including either a latent variable or a single outcome measure. The model paths of interest include intervention status predicting the estimated outcome measure at rescan and neocortex 5-HTT binding at rescan. The estimated outcome measure and neocortex 5-HTT binding at rescan are predicted by the estimated outcome measure and neocortex 5-HTT binding at baseline, respectively, modeling individual differences in these measures at baseline. To allow for an association at baseline, there is a delineated model path from neocortex 5-HTT binding at baseline to the estimated outcome measure at baseline. The black circles represent the latent variable or single outcome measure at baseline and retest, respectively (LV_{ba} = latent variable and SO_{ba} = single outcome at baseline; LV_{re} = latent variable and SO_{re} = single outcome at rescan). The grey boxes predicted by the latent variable represent observed data. For the latent construct of verbal affective memory (LV_{vam}) this includes $Total_{Pos}$, $Total_{Neg}$, and $Total_{Neu}$ recall scores whereas for the latent construct of mental distress (LV_{md}) this includes Total Mood Disturbances (TMD), Global Severity Index (GSI), and Major Depression Inventory (MDI) scores. The hatched grey lines indicate variables estimated with error.

RESULTS

The following gives a brief summary of the study findings. The results of the included studies 1, 2, and 3 are presented in detail in the respective papers.

Study 1:

In this study, we found that ART did not induce within- or between-protocol changes in any of the applied measures of mental distress (POMS, MDI, SCL-92-R, and PSS). Figure 7 shows an overview of the treatment course for the two ART protocols.

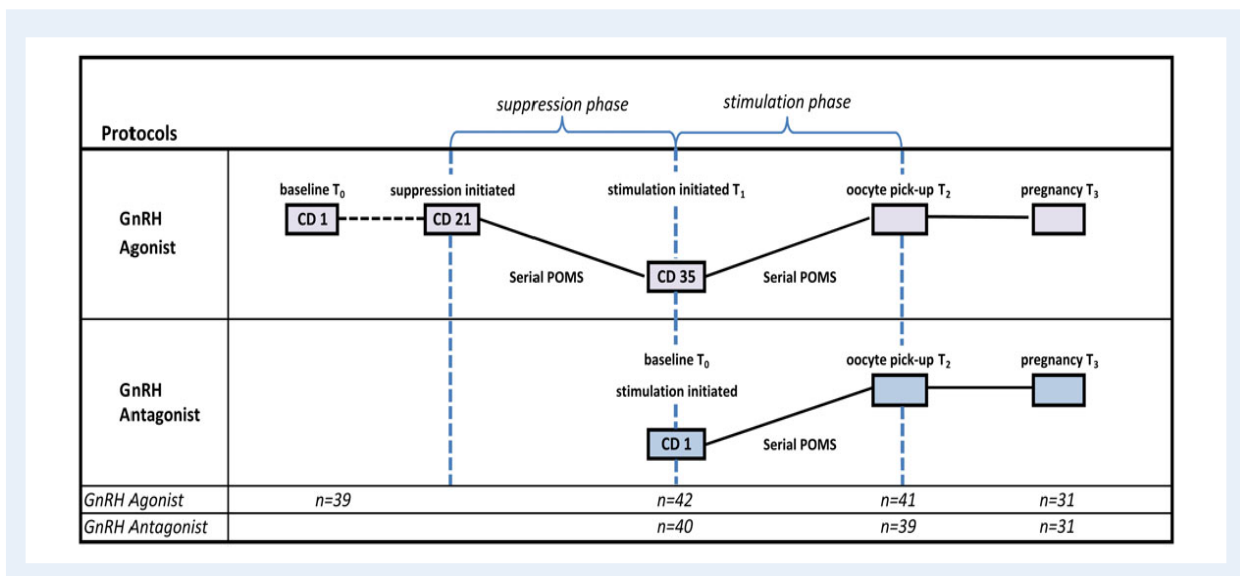

Figure 7: The figure shows an overview of the treatment course, cycle days and time points of assessment in the two protocols

When we investigated the daily reported TMD during treatment, we found that the GnRH antagonist protocol was associated with more pronounced median mood fluctuations during the stimulation phase (antagonist, 11.0 SD, [IQR = 21.1 – 6.1]; agonist, 8.9 SD, [IQR = 11.3 – 5.7], $p = 0.025$) (Table 3). This association became non-significant after applying a Bonferroni-Holm correction.

Protocol and phase	Suppression phase		Stimulation phase		P-value
	Days	SD	Days	SD	
Antagonist (N = 39)	–	–	10	11.0 [21.1–6.1]	0.531
Agonist (N = 37)	14	10.3 [14.9–7.0]	12	8.9 [11.3–5.7]	
Antagonist Stim. versus Agonist Supp.					0.531
Antagonist Stim. versus Agonist Stim.					0.025

Mean duration (days) and median standard deviations (SD) and interquartile ranges in square brackets of daily mood disturbances scores (POMS) during pharmacological treatment with P-values of protocol differences. POMS, Profile of Mood States; Stim, stimulation phase; Supp., suppression phase.

Table 3: The table shows protocol (GnRha versus GnRH antagonist) differences in mood fluctuations during ART treatment.

Neuroticism was highly positively associated with increased levels of mental distress throughout treatment independent of protocols (all p-values < 0.006) and cross-sectional analysis revealed that women with high or low Neuroticism scores at baseline showed a significant trend towards lower chances of a positive pregnancy test (p-value = 0.028) (Figure 8).

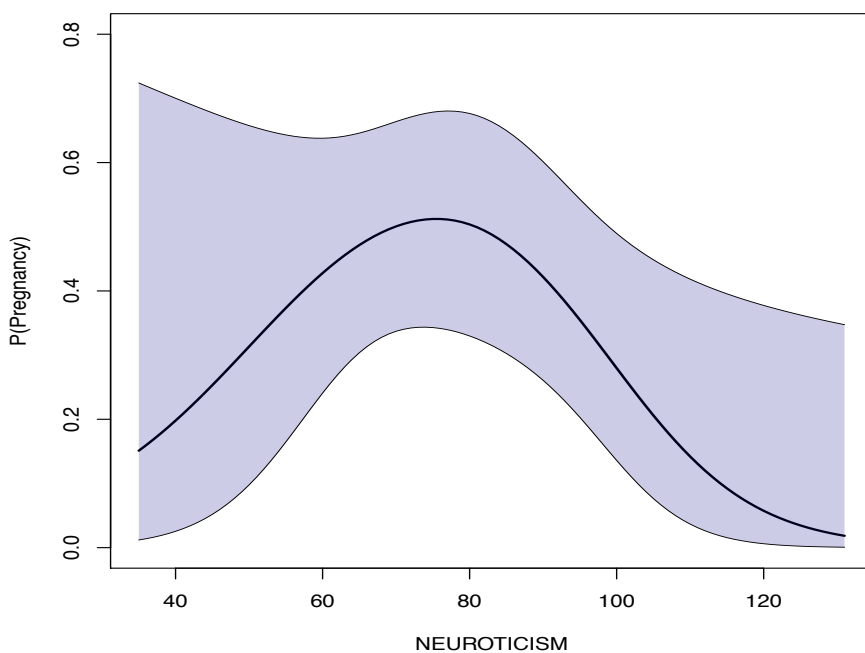

Figure 8: The figure shows that a non-linear association was observed, so that women with high or low Neuroticism scores at baseline showed a significant trend ($p = 0.028$) towards lower chances of pregnancy (defined as HCG>50). This was examined using a logistic regression model with the effects of Neuroticism modeled using a natural cubic spline basis with a single knot located at the median. Although similar trends were observed using different statistical approaches, significance levels varied in both directions with the number and placement of knots, polynomial degree, and type of test. The grey area indicates the 95% confidence interval.

These results imply that mental distress emerging during ART treatment is not causally linked to hypogonadism per se or to choice of protocol. Rather, our data highlight the potential importance of rapid increases in ovarian steroids and of addressing personality traits indexing negative emotionality, i.e. Neuroticism in relation to experienced mental distress during treatment and treatment outcome.

Study 2:

In this study, we found a significant inverse relationship between memory performance on the VAMT-24 and 5-HT₄ receptor binding across the included brain regions (frontal cortex, amygdala, hippocampus and anterior cingulate cortex) in healthy men and women (Estimate, -57.2 [-84.1 - -30.3], $p = 3.1 \times 10^{-5}$). This was analyzed using a two latent variable structural equation model as shown below (Figure 9).

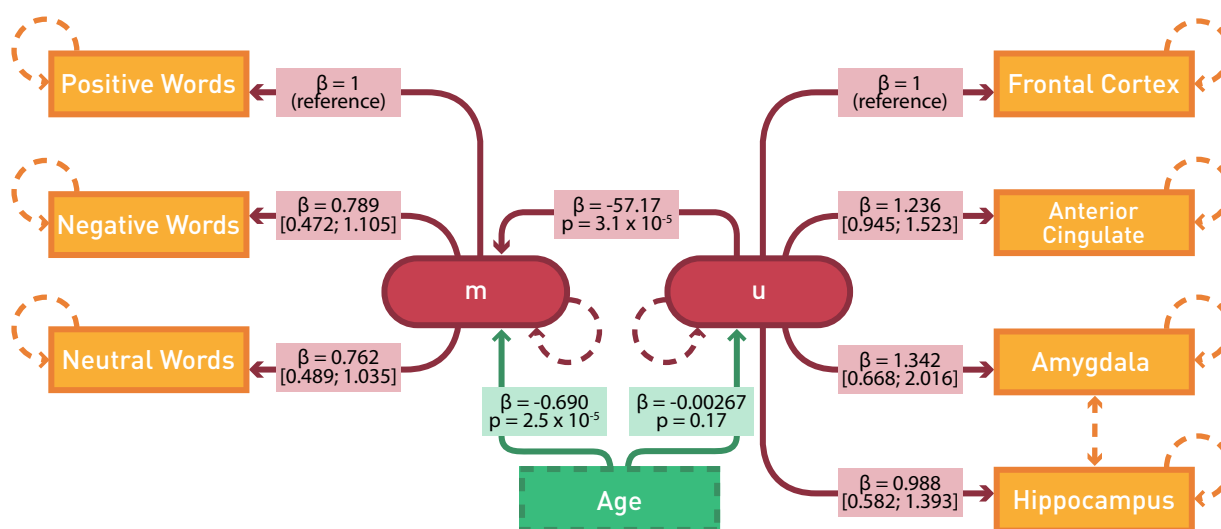

Figure 9: The figure shows a schematic overview of the applied two latent variable structural equation model. The final model is depicted with model paths. The red circles represent the two latent variables (m = memory component and u = 5-HT₄ receptor component). The orange boxes predicted by the latent variable u represent measured regional [¹¹C]SB207145 binding potential values and the orange boxes predicted by the latent variable m represent measured word categories total recall. The green box represents age as a predictor of the two latent variables. The hatched orange line between amygdala and hippocampus indicates additional shared correlation and the remaining hatched red and orange lines indicate they are estimated with error. Parameter estimates (β) are noted for each delineated path in pink and green boxes, which also include 95% confidence intervals for parameter estimates between each latent variables and predicted measures. P-values are given for the association between the two latent variables and for effects of age.

We also found a borderline significant overall difference between word categories in their association with 5-HT₄ receptor binding ($p = 0.06$) and post hoc analyses revealed that the largest difference was between positive and negative word recall, with a steeper negative slope for the association between positive word recall and 5-HT₄ receptor binding as compared to the one for negative word recall (Estimate, -26.9, [-49.5 - -4.3]) (Figure 10).

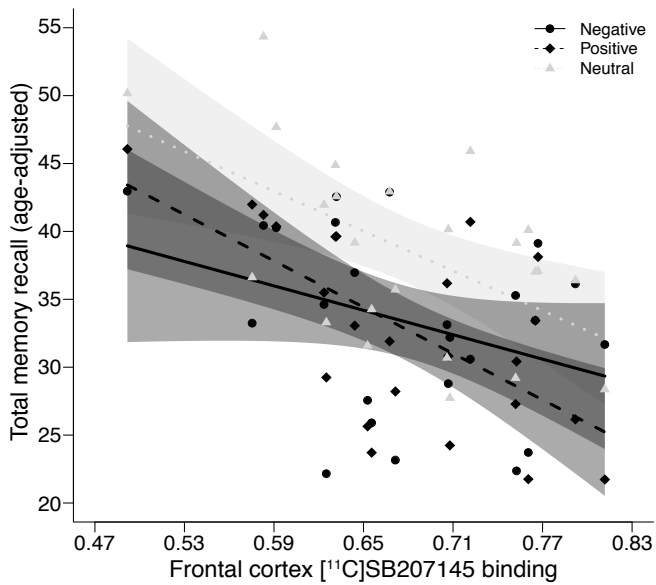

Figure 10: The figure shows a grouped scatter plot of [¹¹C]SB207145 binding potential values plotted against total memory recall. Red, blue, and yellow dots represent negative, positive, and neutral word recall, respectively. Lines and shading for each line represent slope estimates and 95% confidence intervals respectively. The data shown are adjusted for age. Our data indicate an inverse relation between memory recall and [¹¹C]SB207145 binding. They also suggest a steeper slope for positive word recall as compared to negative and that the relative recall between positive and negative words changes with [¹¹C]SB207145 binding. More negative words relative to positive words are recalled with increasing binding and the opposite with decreasing binding.

These findings confirm the presence of a negative association between 5-HT₄ receptor binding and memory performance. In the light that the 5-HT₄ receptor has been shown to be an inversely related biomarker of 5-HT tonus, these findings suggest that higher 5-HT levels are coupled to better memory performance and a relatively better recall for positive words compared to negative words. Thus, this study provides novel evidence linking 5-HT signaling and affective memory biases in healthy humans.

Study 3:

In this study, we utilized the administration of a GnRHa as an experimental risk model for mood disorders, i.e. major depression. Figure 11 shows an overview of the study design with the timing of GnRHa implant or placebo in relation to a menstrual cycle.

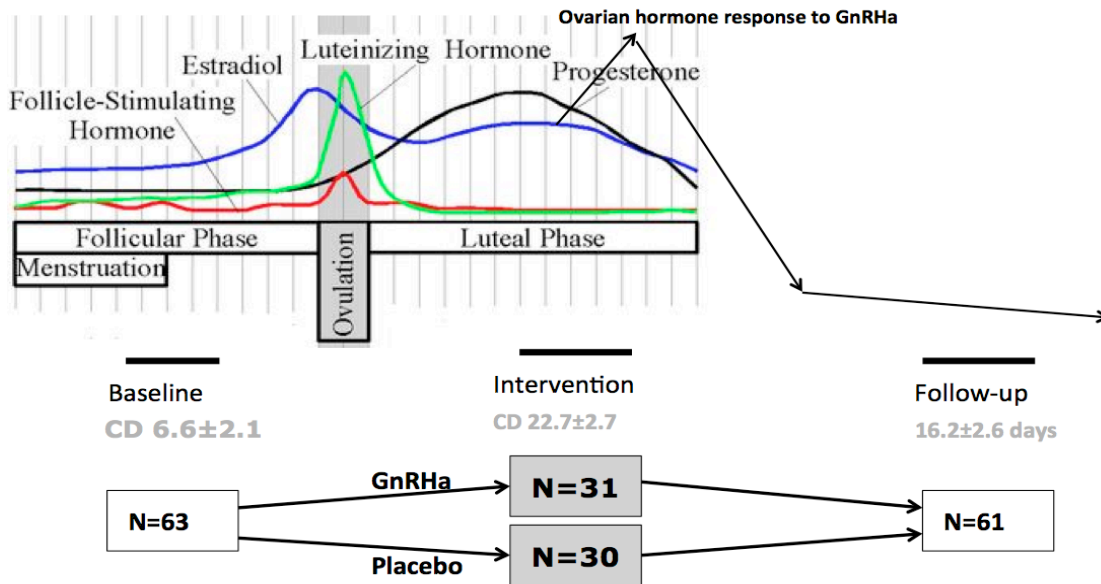

Figure 11: The figure shows an overview of the study design, intervention timing course, and time points of assessment. Daily mood reports were obtained between intervention and follow-up.

Within this model, we demonstrated that a pharmacologically GnRHa-induced ovarian hormone fluctuation in young healthy women decreased speed of basic information processing, i.e. increased mean reaction time (3 - 4 %) (Intervention effect: +7.4 ms, 95% CI: [0.63; 14.1], $p = 0.032$) (Table 4). We found no evidence of a dose-dependent effect of estradiol changes from baseline on reaction time in the GnRHa treated group.

Table 4: Model path analyses for direct and indirect effects of intervention

Model outcome	Path analyses (n=61)	Estimate \pm SE	P-value	95% Confidence interval	
				2.5%	97.5%
LV_{vam}					
Direct path	LV _{vam} <- intervention	1.65 \pm 1.28	0.197	-0.86	4.16
Indirect path	LV _{vam} <- 5-HTT BP _{nd}	15.25 \pm 17.92	0.395	-19.87	50.37

Indirect path	5-HTT BP _{nd} <- intervention	0.002 ± 0.01	0.873	-0.02	0.02
LV_{md}					
Direct path	LV _{md} <- intervention	0.004 ± 0.04	0.929	-0.08	0.09
Indirect path	LV _{md} <- 5-HTT BP _{nd}	1.0 ± 0.37	0.006	0.28	1.72
Indirect path	5-HTT BP _{nd} <- intervention	0.002 ± 0.01	0.873	0.019	0.02
PSS					
Direct path	PSS <- intervention	1.43 ± 0.95	0.134	-0.44	3.3
Indirect path	PSS <- 5-HTT BP _{nd}	-14.4 ± 10.28	0.161	-34.57	5.75
Indirect path	5-HTT BP _{nd} <- intervention	0.002 ± 0.01	0.873	-0.02	0.02
SRT					
Direct path	SRT <- intervention	7.4 ± 3.44	0.032	0.63	14.1
Indirect path	SRT <- 5-HTT BP _{nd}	-25.44 ± 44.2	0.565	-112.0	61.3
Indirect path	5-HTT BP _{nd} <- intervention	0.003 ± 0.01	0.792	-0.018	0.023

The table shows model path analyses for direct and indirect effects of intervention (GnRha versus placebo). Data is presented with estimates and SE (standard errors) including 95% confidence interval. P-values denote the direct and indirect effects of the delineated model paths (<-). LV_{vam}: The shared correlation across total recall of positive words, total recall of negative words, and total recall of neutral words, LV_{md}: The shared correlation across Total Mood Disturbances (TMD), Global Symptom Index (GSI), and Major Depression Inventory (MDI), PSS: Perceived Stress scale, SRT: Simple reaction time, 5-HTT: serotonin transporter, BP_{nd}: binding potential.

We also found that women undergoing GnRHa intervention exhibited more labile daily mood compared to placebo ($X^2 = 16.0$, $df = 4$, $p = 0.003$) (Figure 12) in a manner dependent on baseline levels of mood disturbances. The same trend was observed when anchoring the analyses in the Neuroticism score at baseline so that women high in Neuroticism were differentially affected by GnRHa intervention compared to placebo ($X^2 = 12.7$, $df = 4$, $p = 0.013$).

No effects of GnRHa-induced hypogonadism were observed for the latent constructs of verbal affective memory and mental distress scores, respectively (Table 4). Changes in 5-HT signaling indexed by 5-HTT binding in neocortex did not mediate intervention effects on any of the applied outcome measures. We found no overall evidence for Neuroticism moderating the intervention effect on the included outcome measures (all p-values > 0.077). Within the GnRHa group, a larger decline in serum estradiol from baseline was associated with higher

levels of perceived stress.

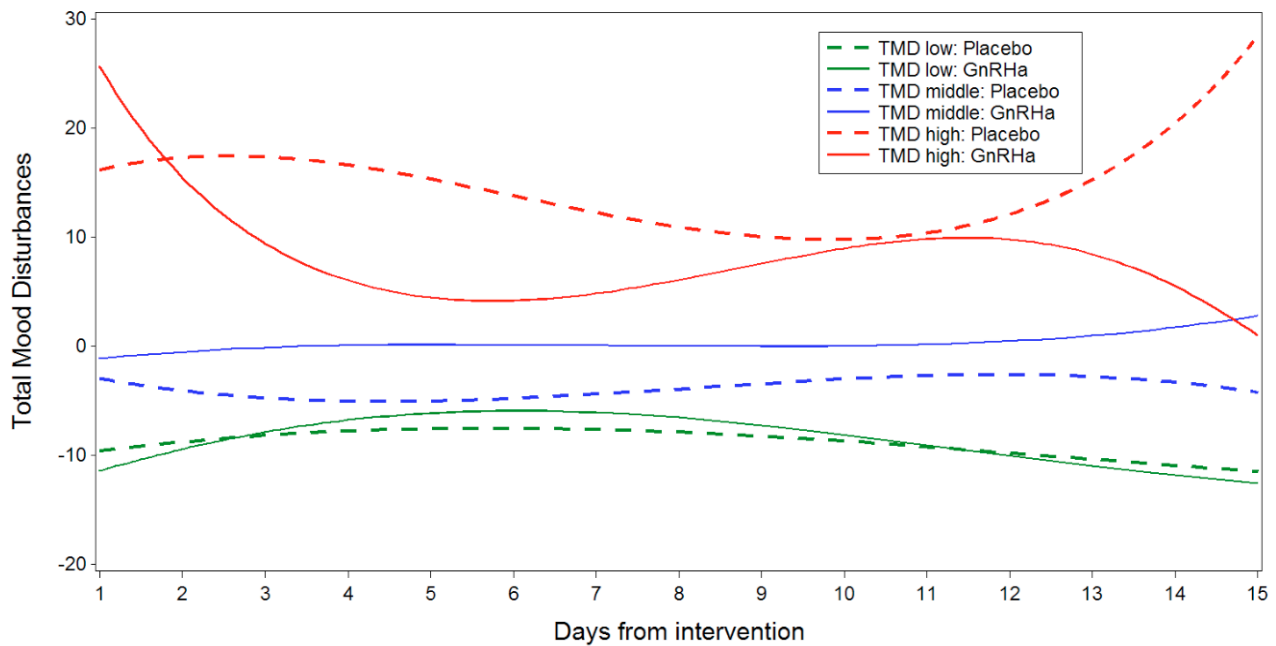

Figure 12: The figure shows the development of serial daily TMD as a function of intervention group and baseline TMD (baseline TMD groups, low: TMD < -8, moderate: -8 < TMD < +8, high: TMD > 8). Baseline TMD significantly moderated the GnRHa intervention effect on TMD development ($p = 0.003$). Specifically, GnRHa intervention significantly affected TMD development in women with high baseline TMD whereas there was no effect of intervention in women with moderate or low baseline TMD. When we tested whether each of the TMD trajectories was constant, only for women undergoing GnRHa intervention with high TMD scores at baseline could the hypothesis of a time constant TMD level be rejected (0.016). Thus, only for this sub-group of women receiving GnRHa did the development of TMD during intervention deviate significantly from a straight line. TMD: Total Mood Disturbances, GnRHa: Gonadotropin-Releasing Hormone agonist.

These results suggest that in healthy young women speed of information processing may be compromised by transient hormone fluctuations, whereas impairments in verbal affective memory recall and increased self-reported mental distress may not be causally linked to hypogonadism per se. The trajectory or development of mood disturbances, as measured on a daily basis, appear to be affected by transient hormone fluctuations, especially in a sub-group of women high on state levels of emotional distress at the time of intervention.

Cross-study comparisons (not included in the papers):

In a *post hoc* cross-study comparison of levels of mental distress and Neuroticism between women undergoing ART-treatment (study 1) and young healthy non-treated women (study 3) at baseline, women undergoing ART-treatment exhibited significantly higher levels of mental distress (Figure 14). However, no difference in Neuroticism was observed (Figure 13). Thus, these analyses show that elevated levels of mental distress mark women who are seeking treatment for their infertility compared to healthy women not seeking treatment. These differences do not appear to be caused by differences in personality, and levels of mental distress on average did not reach clinical levels in women undergoing ART-treatment in study 1. The women's levels of Neuroticism in study 1 and 3 did not differ significantly from the general Danish population (Skovdahl Hansen *et al.*, 2003).

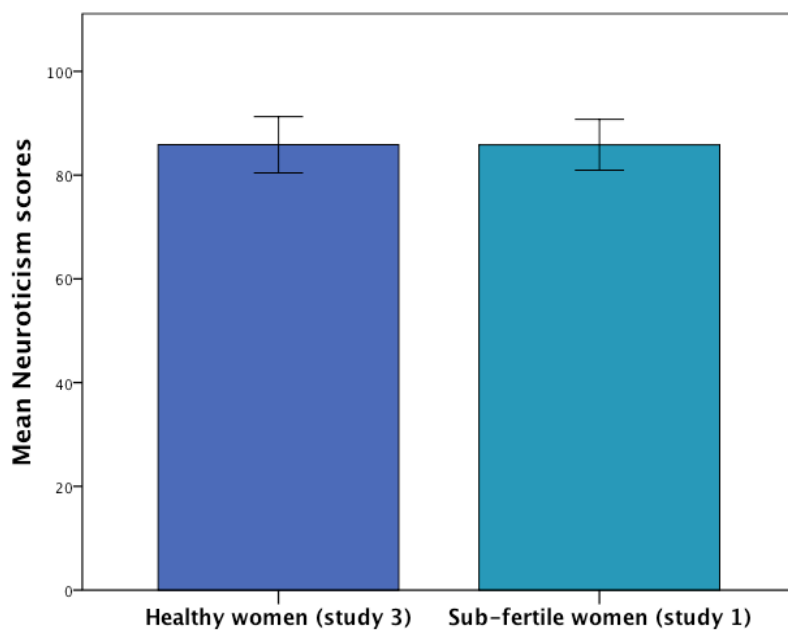

Figure 13: The figure shows mean Neuroticism scores with 95 % confidence interval error bars in study 1 and 3. No significant difference in Neuroticism was observed ($p = 0.998$) between women undergoing ART-treatment (study 1) and healthy non-treated women (study 3).

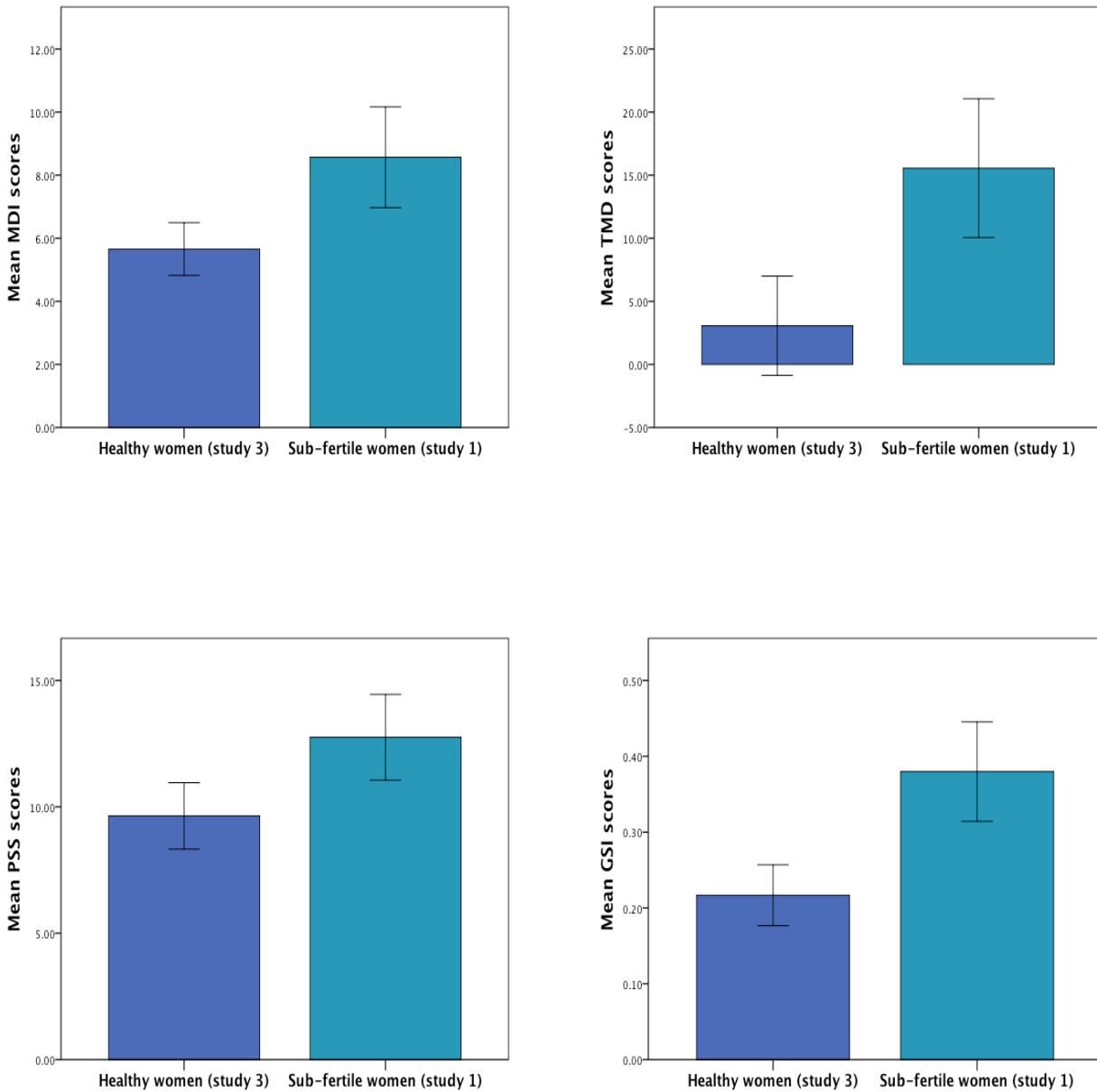

Figure 14: The figure shows mean Major Depression Inventory (MDI), Total Mood Disturbances (TMD), Perceived Stress Scale (PSS), and Global Severity Index (GSI) scores with 95 % confidence interval error bars in study 1 and 3. Significant differences were found for MDI ($p = 0.004$), TMD ($p = 0.001$), PSS ($p = 0.007$), and GSI ($p < 0.001$) so that women undergoing ART-treatment (study 1) exhibited increased levels mental distress compared to healthy non-treated women (study 3).

DISCUSSION

The present thesis is based on an integrated approach to understanding vulnerability factors in relation to mood disorders in healthy individuals. In particular, an attempt was made to set up a vulnerability model for major depression in women by utilizing a pharmacological GnRHa-induced biphasic ovarian hormone fluctuation over a period of approximately 14 days in premenopausal asymptomatic women and in premenopausal women undergoing ART-treatment. Within this model we explored the role of changes in 5-HTT and the personality trait Neuroticism as a mediating and modulating factor, respectively, for the effects of GnRHa intervention on mental distress and cognition. To probe potential depressogenic effects of ovarian hormone manipulations on mnemonic processes we used the VAMT-24, which was also tested in a sample of 24 young healthy men and women with regards to its sensitivity to endogenous 5-HT levels as indexed by 5-HT₄ receptor binding.

The interpretations of the obtained results are discussed in detail in paper 1, 2, and 3 and the reader is referred to these papers for a more comprehensive discussion of implications and comparison with existing literature. In the following, a discussion of main findings is presented. First the main lines in the results and interpretation of self-reported data across study 1 and 3 are discussed. Second, the main lines in the results and interpretation of cognitive data across study 2 and 3 are discussed. Third, the main lines in the results across study 2 and 3 regarding the role of 5-HT is discussed, and fourth, the primary methodological considerations across all three studies are outlined.

Discussion of main findings

Effects of ovarian hormone manipulations on mental distress

Contrary to our *a priori* hypotheses in study 1 and 3, the early hypogonadal state achieved by suppression of ovarian hormones with GnRHa administration was not associated with elevated self-reported symptoms of mental distress in women undergoing ART or in premenopausal asymptomatic women. Thus, our results suggest that the hypogonadal state does not per se induce mental distress in healthy young women. When we obtained information regarding depressive symptoms of the women in study 3, based on a semi-structured interview (the Hamilton Depression Rating Scale, HAM-D), we found that GnRHa treatment triggered subclinical depressive symptoms relative to placebo (Frokjaer *et al.*, 2015).

Interestingly this effect did not translate clearly to the women's self-reported levels of mental distress, which may point to an important distinction between self-reported versus interview-based information.

It is possible that our GnRHa model simulates an early onset of hormone-triggered disturbance of mood more driven by somatic and basic psychobiological changes, e.g. sleep, as opposed to a manifest depressive state, which would more likely inform top-down elaborative processes such as self-perception and mood. The noted association between greater magnitude of change in estradiol from baseline and increased perceived stress in the GnRHa group may also support this, as stress often precedes a depressive episode and has been coupled to fluctuating hormones (Hoyt and Falconi, 2015). Thus, based on the observed discrepancies between self-reported versus interview-based information, we speculate whether GnRHa manipulation induces a form of temporary alexithymia, i.e. inability to identify and verbalize emotions in the self, due to a dissonance between actual mental state and established self-schemata of usual mental state. It was on several occasions observed by the tester in study 3 that women, who were crying and showing signs of emotional distress at follow-up reported that they believed to have received placebo, while they were actually hormone manipulated.

On the other hand, women undergoing ART-treatment in study 1 exhibited significantly increased levels of mental distress compared to the healthy women in study 3 (figure 14). As such, they must have had some established awareness of their distress, which in some cases would have build on years of frustration over reproductive difficulties, but this awareness may have escaped the relatively short impact of ART-related hormonal treatment. Interestingly, infertile women have been shown to exhibit significantly higher rates of alexithymia compared to fertile women (Lamas *et al.*, 2006). Likewise, women with premenstrual dysphoric disorder show higher rates of alexithymia compared to controls (De Berardis *et al.*, 2005) and the development of depressive symptoms in peripartum women has been positively coupled to higher rates of alexithymia (Le *et al.*, 2007). In general, higher rates of alexithymia is found in populations with somatoform and depressive disorders (De Gucht and Heiser, 2003, Duddu *et al.*, 2003), supporting that it may be a factor worth considering in future studies. Thus, self-report measures may be useful for elucidating perceived experiences, but may provide only a partial test of the actual impact of pharmacologically induced hypogonadism on processes of relevance for development of the depressed state.

Daily mood and the role of Neuroticism

A unique and elaborate part of study 1 and 3 was the daily collection of mood reports during ART-treatment and intervention (GnRHa versus placebo), respectively. This was a time-consuming and challenging task for the women, however, high compliance rates were observed in both studies. In study 1, we assigned the standard deviation around each woman's own mean as an index of fluctuations in serial daily reported mood disturbances during ART-treatment. This decision was based on an evaluation showing no significant linear trends, supporting that level of mood disturbances over the course of treatment fluctuated around a quite stationary mean in both protocols. Using this approach we found a trend that women in the GnRH antagonist protocol exhibited more pronounced mood fluctuations compared to women in the GnRHa protocol during the stimulation phase, suggesting that ovarian hormone stimulation in the absence of prior suppression with GnRha was more distressing for women undergoing ART-treatment. However, factors unrelated to hormone treatment may have contributed to the observed difference given that time of treatment initiation differed between the protocols (Figure 7).

Based on these preliminary findings, we wanted to model the development of mood disturbances during intervention (GnRHa vs. placebo) by applying a more advanced statistical approach in study 3. Hence, the development in mood disturbances scores during the first 15 days after intervention was modeled using a third degree polynomial and the interaction effect between baseline mood and intervention status was tested in a mixed model. Here we found that a biphasic ovarian hormone response to GnRHa, i.e. initial flare-up and subsequent hypogonadism, in a sub-group of women high in state levels of mood disturbances was associated with a progression in mood disturbances so that the initial GnRHa-induced estradiol flare-up decreased levels of mood disturbances (day 4-6), which then increased again coinciding with the drop in estradiol to hypogonadal state (day 10-12) (Figure 12). The same trend was observed when anchoring the analyses in the Neuroticism score at baseline. Supporting the latter finding, Neuroticism was also predictive of more pronounced mood fluctuations during the stimulation phase in women undergoing ART (study 1). However, GnRHa did not significantly affect net measures of mood disturbances and mental distress at follow-up (i.e. early hypogonadal state), but rather the trajectory of mood disturbances differed in this sub-group of women. Thus, the susceptibility to the hormone-triggered mood fluctuations appears to depend on both state and trait aspects of mental status at the time of

intervention, partially supporting a vulnerability approach to explain why only some women react with depressive symptoms to fluctuating ovarian hormone levels. Study 3 is the first study to collect serial daily mood reports from young healthy women while undergoing a controlled ovarian hormone fluctuation. We propose future studies to expand such a design to elucidate phase specific changes and not solely changes related to the hypogonadal state per se.

In study 1, high or low Neuroticism scores at baseline showed a significant trend towards subsequent negative pregnancy tests. However, the relatively few observations in the lower end of the Neuroticism spectrum in this study makes interpretation of the association between low Neuroticism scores and chances of pregnancy somewhat inconclusive, as is also reflected by the broad confidence interval (Figure 8). Of particular relevance for clinicians handling the treatment of sub-fertile women, personality appears to be a stronger predictor than choice of protocol for the mental distress experienced by women undergoing ART. If replicated, the ease of administration and the clinical relevance make ratings of Neuroticism an applicable tool for health care professionals in evaluating ART-related vulnerability to mental distress.

Effects of ovarian hormone manipulations on reaction time and VAMT-24

In study 3, we demonstrated that a pharmacologically GnRHa-induced ovarian hormone fluctuation decreased speed of basic information processing, i.e. increased mean reaction time (3-4 %), however, we found no evidence of a dose-dependent effect of estradiol changes from baseline on reaction time in the GnRHa treated group. This finding is consistent with studies showing a beneficial effect of hormone therapy on information processing speed in premenopausal women (Alhola *et al.*, 2010), in women > 60 years of age (Schiff *et al.*, 2005b), and in postpartum women (de Groot *et al.*, 2006), whereas an earlier study showed no effects of early pregnancy on information processing speed (de Groot *et al.*, 2003). Thus, fluctuating ovarian hormone levels may adversely influence basic information processing in women; however, more studies are needed to replicate these findings.

Contrary to our hypothesis, no effects of GnRHa-induced early hypogonadism were observed for overall verbal affective memory recall or shift in relative recall rates between word-categories. Thus, our results suggest that the GnRHa-induced early hypogonadal state does not induce impairments in verbal affective memory recall or a depressogenic cognitive

bias in healthy young women, supported by the lack of increase in self-reported mental distress.

Based on a meta-analysis of 14 studies, it has been proposed that memory measures where strategic, self-initiated retrieval and executive monitoring is demanded, e.g. un-cued verbal memory recall tasks, may be especially sensitive to the hormonal effects of pregnancy and the postpartum period (Henry and Rendell, 2007). This aligns with a meta-analysis in menopausal women where verbal memory function was shown to be particularly sensitive to HRT (LeBlanc *et al.*, 2001) and findings from surgically postmenopausal women suggesting selective effects on verbal memory (Henderson and Sherwin, 2007). The proposition is further supported by studies showing that verbal memory fluctuate in concert with ovarian hormone changes during the menstrual cycle, pregnancy, and postpartum period (Sherwin, 2012). Also, the large randomized trial Women's Health Initiative Memory Study (WHIMS) failed to replicate the protective effect of hormonal treatment on memory; in one study active treatment was even associated with higher risk of dementia (Shumaker *et al.*, 2003), however, they did not include a verbal memory test (discussion of further methodological issues can be found in Sherwin, 2005). Together these findings point to verbal memory tasks as mandatory in studies targeting estrogenic effects on cognition.

The VAMT-24 was selected based on the assumption that it would be a representative marker of changes in ovarian hormones as it consists of low-arousal emotional words and puts a significant cognitive demand on attending to, learning, encoding and retrieving the material without cues (Jensen *et al.*, in press). Thus, we speculate that in healthy young women bottom-up processes, i.e. speed of information processing, may be compromised by transient hormone fluctuations, whereas top-down processes, i.e. verbal affective memory recall, appear not to be affected. Such top-down effects may be most apparent in women in life-phases where changes in hypothalamic-pituitary function alter estrogen sensitivity such as in menopausal transition (Weiss *et al.*, 2004) or in life-phases where a combination of hormonal changes and strain on cognitive top-down processes is evident as for instant during the postpartum period (caused by e.g. sleep deprivation, and providing constant physical and emotional care for an infant). It is, however, possible that had we included high-arousal words in VAMT-24, we may had been better able to target potential bottom-up effects of GnRH α .

The role of 5-HT

In study 2, we attempted to probe the relation between 5-HT signaling and VAMT-24 in parallel with study 3, where we wanted to study potential mediated effects through changes in 5-HT signaling of GnRHa intervention on VAMT-24. We have previously shown that 5-HT₄ receptor availability is inversely related to cerebral 5-HT tonus in humans; three weeks of fluoxetine administration to healthy volunteers decreased 5-HT₄ receptor binding (Haahr *et al.*, 2014) and this was also the case for rats exposed to three weeks of paroxetine administration (Licht *et al.*, 2009). Corroborating this, the results in study 2 indicated a significant inverse relationship between VAMT-24 performance and 5-HT₄ receptor binding, supporting high levels of 5-HT, i.e. low 5-HT₄ receptor binding, as predictive of better VAMT-24 performance. (Figure 9) We also found a borderline significant overall difference between word categories in their association with 5-HT₄ receptor binding and post hoc analyses revealed that the largest difference was between positive and negative word recall, with a steeper negative slope for the association between positive word recall and 5-HT₄ receptor binding as compared to the one for negative word recall (Figure 10). This also preliminarily supports the proposition that lower 5-HT levels underlie negative memory bias tendencies. Together, these findings reinforce a link between an endogenous feature of brain 5-HT signaling and memory performance; a critical and often lacking piece of evidence supporting observed brain-behavior relations.

In study 3 we used changes in 5-HTT as a biomarker of GnRHa-induced effects since the 5-HTT is in a key position to modulate 5-HT neurotransmission and respond to central 5-HT innervation, e.g. by ovarian hormones. However, contrary to our *a priori* hypothesis in study 3, changes in 5-HT signaling indexed by 5-HTT binding in neocortex did not mediate intervention effects on any of the applied outcome measures. This is consistent with the fact that no main effects of intervention status on 5-HTT changes were found in initial analyses (Frokjaer *et al.*, 2015). It remains to be clarified whether this is (1) due to an inefficiency of the applied GnRHa model to induce changes in synaptic 5-HT levels, (2) due to an inability of *in vivo* 5-HTT binding to reliably measure direct innervation effects of the applied GnRHa model, or (3) due to an inability of *in vivo* 5-HTT binding to reliably measure changes in 5-HT levels within the time span of the applied GnRHa model .

Methodological considerations

The included studies in this thesis presents with several strengths. Study 1 and 3 had controlled randomized prospective study designs, and study 3 was furthermore double-blinded. They also employed an extensive set-up of well-validated and reliable psychometric instruments covering baseline to follow-up including daily reports during pharmacological treatment. However, the findings reported in this thesis and the included papers should be interpreted under the following potentially important methodological limitations.

The use of healthy study participants

Study 2 and 3 included only healthy volunteers. Therefore men and women with current and previous psychiatric illness, including premenstrual dysphoric disorder for women, and a family history of mood disorders were excluded from our study populations. In study 1, women with prior or current use of antidepressant medication were also excluded. This is likely to have biased our study samples towards low risk for developing subclinical depressive symptoms (study 1 and 3) and low degree of serotonergic vulnerability and affective bias in VAMT-24 performance (study 2). This tendency is also reflected by the high educational scores in study 2 and 3 pointing to a high socio-economic status for the included participants; many of whom were students in higher-level educations. We may therefore have underestimated the potential effects of a GnRHa-induced hormone response and the association between 5-HT₄ receptor and affective bias in more vulnerable populations, e.g. men and women recovered from major depression or with a family history of mood disorders. In study 2, we were also not able to address the potential moderating role of gender for the investigated association between central 5-HT₄ receptor binding and VAMT-24 performance, due to the low number of women included. Given the higher prevalence of major depression in women compared to men and earlier reported gender differences in 5-HT₄ receptor binding (Madsen *et al.*, 2011) this is relevant to consider in future studies.

The use of self-report inventories

Despite comprehensive self-report inventories such as the NEO PI-R, POMS, PSS, MDI, and SCL-92-R being considered the golden standard for measuring personality traits and mental distress in both clinical and research settings, introspection is an inherent part of this methodology. A weakness in any self-report measure is the risk that instead of measuring the

underlying targeted mental construct you are in fact measuring the individual's self-perception of that construct, which may or may not be reliable (Baumeister *et al.*, 2007). As indicated by the discrepancies in results between self-report and interview-based mental status in study 3, it might be beneficial to consider supplementing self-report information with other more qualitative forms of psychometric tools such as standardized interviews or behavioral observations in future studies. Such qualitative measures may be less vulnerable to response bias, i.e. censorship or systematic manipulation of answers on items (Domino & Domino, 2006).

We did not include a measure of alexithymia to elucidate the role of emotional awareness for self-reported mental distress in study 1 and 3, which appear to represent a risk mechanism in itself for developing depressive symptoms in response to hormone changes. Interestingly serial daily reports of mood contained additional information to actual mood state since it allowed us to model the trajectory over time revealing differences in *how* women reported their mood during intervention and treatment. Although quite time consuming for the women, it may be a way to utilize self-report measures in a manner that targets the “*how*” and not so much the “*what*” in the information obtained, perhaps to some extent bypassing the self-report biases described above.

Low arousal words and the design of VAMT-24

A problem with using many of the established verbal learning tests, e.g. Reys Auditory Verbal Learning Test, is that they were developed for clinical samples. Thus, when applying them to healthy samples they present with severe ceiling effects (Haahr *et al.*, 2013). In study 2 and 3 we avoided such ceiling effects in affective memory recall by using the VAMT-24, which was specifically developed for use in healthy samples (Jensen *et al.*, in press). However, the VAMT-24 is based on low-arousal emotional words and may as such not be sufficiently sensitive to subtle changes in hormone levels, which could perhaps be better targeted using high arousal words. On the other hand, an advantage of using low-arousal words may be that top-down cognitive characteristics of a depressed mind-set can be assessed without the confounding effects of high arousal.

In study 2, we supported a role of the 5-HT system for affective cognitive orientation among healthy individuals. However, although the VAMT-24 is designed to tease apart immediate, short-term, and long-term recall, these recall scores were highly correlated within

each word category (positive, negative and neutral) in our samples (study 2 and 3). Thus, we did not find evidence for a differential effect between immediate, short-term, and long-term recall scores, and hence, were not able to disentangle the affective cognitive processes of encoding, retrieval and consolidation. We had relatively small sample sizes and we may therefore have been underpowered to detect and disentangle such processes.

Also, in study 2, we were not able to address region-specific changes in 5-HT release in response to VAMT-24 performance with the applied static PET-signal.

CONCLUSION AND PERSPECTIVES

This thesis presents three studies aiming to elucidate the complex interplay between neuroendocrine and cognitive factors involved in risk for major depression. In particular, we utilized a GnRHa-induced biphasic ovarian hormone fluctuation in study 1 and 3 to experimentally model and explore risk mechanisms of developing depressive symptoms in female life phases, where ovarian hormones fluctuate or rapidly decline, i.e. postpartum and during menopausal transition. Within this model we tested the effects of an early GnRHa-induced hypogonadal state on verbal affective memory recall, simple reaction time, and self-reported mental distress and whether changes in 5-HTT binding mediated such effects. We also for the first time tested, in an elaborative set-up of daily mood reports, the effects of undergoing a biphasic hormone fluctuation on mood development from intervention to early hypogonadal state (app. 15 days) and the modulating role of personality trait Neuroticism.

The results obtained from these two studies suggest that in healthy young women bottom-up processes, i.e. speed of information processing, may be compromised by transient hormone fluctuations, whereas top-down processes, i.e. verbal affective memory recall (VAMT-24) and perceived levels of mental distress in the early hypogonadal state are not affected. Importantly, the susceptibility to hormone-triggered mood fluctuations appears to depend on both state and trait aspects of mental status in a sub-group of women so that women high in state measures of emotional distress at baseline exhibited more labile mood in response to GnRHa compared to placebo. Changes in 5-HTT binding did not mediate GnRHa-induced effects on any of the applied outcome measures. In study 2, we found for the first time a highly significant inverse relation between the 5-HT₄ receptor and verbal affective memory recall in healthy individuals; a coupling that appeared to be more correlated for positive words compared to negative words. As the 5-HT₄ receptor is thought to be an inversely related biomarker of central 5-HT signalling, we interpret this finding to signify that higher levels of 5-HT predict better verbal affective memory performances. Importantly this study supports the sensitivity of VAMT-24 to endogenous 5-HT levels, although we were not able to modulate this association within our GnRHa model using 5-HTT binding as a biomarker of GnRHa-induced changes in study 3.

Research perspectives

The work generated in this thesis points to several research perspectives:

1) Based on our results in study 2 and the reviewed literature on estrogens and verbal memory in this thesis, we propose the VAMT-24/26 and the 5-HT₄ receptor as key candidates for future studies investigating the interaction between estrogenic and serotonergic systems. In study 3 no GnRHa-induced effects on VAMT-24 were observed, however, the VAMT-24 may be better suitable to target real-life settings, such as postpartum and during menopausal transition, where ovarian hormones change in the context of psychological challenges and adjustments, i.e. becoming a new family or ending the era of a reproductive life and entering a mature age.

2) Based on the findings from study 2 and 3, an important next step would be to investigate several biomarkers (5-HT₄ receptor and 5-HTT) related to endogenous 5-HT tonus together in relation to VAMT-24 performance, i.e. a cross-sectional analysis of study 2 and 3 combined, in order to gain more comprehensive insight into serotonergic involvement in affective memory biases in healthy individuals. Future studies integrating a pharmacological challenge of the 5-HT system with a PET radioligand sensitive to acute changes in brain 5-HT levels would help elucidate how such region-specific dynamics are related to affective memory recall.

3) Based on the findings from study 1 and 3, we propose that future studies in young healthy women would benefit from a combination of pharmacological challenges and experimentally induced stress, or the use of high-risk populations, to get a more complete understanding of the risk mechanisms involved in a depressive response to ovarian hormone fluctuations in real-life settings. Such studies may benefit from including measures of sleep, stress, and bottom-up related tasks, e.g. reaction time, attention-based tasks.

4) Based on the findings from study 1 and 3, future studies are needed to elucidate the potential mediating role of alexithymia in women undergoing controlled hormone fluctuations for the development of depressive symptoms based on both self-reported and interview-based measures.

5) Based on our results in study 1, further longitudinal investigations of the effect of personality and mental distress for successful ART treatment outcome are warranted; ideally with clinical end points, such as number of live children born, and infant health measures.

6) Based on the overall findings from this thesis, we propose in a future study to characterize neuroendocrine and psychological signatures of pre- to postpartum transition in women at high versus low risk for postpartum depression and to map the consequences for mother-infant social interaction and key markers of infant biology and behaviour.

Such a study may crucially advance our understanding of how the pre- to postpartum transition triggers depressive symptoms and what characterizes vulnerability for PPD by employing some of the methods used in this thesis. In particular, it could provide insight into whether serotonergic brain tonus as indexed by the 5-HT₄ receptor is off-set in PPD and elucidate the broader affective cognitive context in PPD and high-risk women as assessed by the VAMT-24 and the outlined self-report set-up in study 1 and 3. In addition, further affective and social cognitive tests and biological markers, e.g. oxytocin and cortisol responses, could also be included. Specifying mother-infant interactions and attachment status by employing psychological observational methods, e.g. the strange situation and videotaped social interaction episodes, would be an exciting next integrative step within the neuroscientific field of mood disorders.

Delineating the brain and cognitive risk architectures of PPD will ideally pave the way for stratified, targeted and comprehensive strategies to treat and prevent PPD, and thus hold potential to promote infant health.

Promoting an integrated approach to vulnerability for major depression

This thesis builds on an integrated experimental approach to the investigation of neuroendocrine and psychological factors involved in risk for developing major depression, inspired by the tenets of the bio-psycho-social model. The major strength of such an approach is that it draws upon the capacity of several scientific disciplines, i. e. neurobiology, endocrinology, psychology, and pharmacology to elucidate and integrate knowledge across disciplines. However, while this holistic approach has intuitive validity, integrating the proposed components within a scientific framework is a significant challenge in at least three areas: (1) Integrating expertise in biological, psychological, and environmental academic

disciplines, (2) formulating relevant hypotheses of causal interplay and applying relevant scientific methods to address such hypotheses, and (3) applying statistical models and tools to analyse and interpret multivariate and complex data. In this sense, the studies presented in this thesis are an attempt at accommodating these challenges, while learning and experiencing the manifold factors that needs to be taken into consideration.

In Denmark no current integrated master-level education in neuroscience exists, which means that the endeavour to bridge knowledge from psychology and neurobiology, including the methods involved in these disciplines, is up to the initiative and eagerness of the individual to learn more about fields outside one's academic expertise. I come from a background of clinical psychology and have found great pleasure in learning more about the neuroendocrine factors involved in human behaviour. I hope that this thesis will encourage further integrated research and that the need for an integrated master education in neuroscience in Denmark will be met in the future.

REFERENCES

- Akiskal, H. S. & Benazzi, F.** (2006). The DSM-IV and ICD-10 categories of recurrent [major] depressive and bipolar II disorders: Evidence that they lie on a dimensional spectrum. *J Affect Disord* **92**, 45-54.
- Alhola, P., Tuomisto, H., Saarinen, R., Portin, R., Kalleinen, N. & Polo-Kantola, P.** (2010). Estrogen + progestin therapy and cognition: a randomized placebo-controlled double-blind study. *J Obstet Gynaecol Res* **36**, 796-802.
- Almeida, O. P., Lautenschlager, N. T., Vasikaran, S., Leedman, P., Gelavis, A. & Flicker, L.** (2006). A 20-week randomized controlled trial of estradiol replacement therapy for women aged 70 years and older: Effect on mood, cognition and quality of life. *Neurobiology of Aging* **27**, 141-149.
- Amin, Z., Gueorguieva, R., Capiello, A., Czarkowski, K. A., Stiklus, S., Anderson, G. M., Naftolin, F. & Epperson, C. N.** (2006). Estradiol and Tryptophan Depletion Interact to Modulate Cognition in Menopausal Women. *Neuropsychopharmacology* **31**, 2489-2497.
- Aveleyra, E., Carranza - Lira, S., Ulloa - Aguirre, A. & Ostrosky - Solís, F.** (2005). Cognitive effects of hormone therapy in early postmenopausal women. *International Journal of Psychology* **40**, 314-323.
- Barlow, D. H.** (1998). GnRH agonists and in vitro fertilization. *J Reprod Med* **43**, 245-251.
- Barth, C., Villringer, A. & Sacher, J.** (2015). Sex hormones affect neurotransmitters and shape the adult female brain during hormonal transition periods. *Frontiers in Neuroscience* **9**.
- Baumeister, R. F., Vohs, K. D. & Funder, D. C.** (2007). Psychology as the Science of Self-Reports and Finger Movements: Whatever Happened to Actual Behavior? *Perspectives on Psychological Science* **2**, 396-403.
- Bech, P., Rasmussen, N. A., Olsen, L. R., Noerholm, V. & Abildgaard, W.** (2001). The sensitivity and specificity of the Major Depression Inventory, using the Present State Examination as the index of diagnostic validity. *J Affect Disord* **66**, 159-164.
- Beck, A. T.** (2008). The evolution of the cognitive model of depression and its neurobiological correlates. *Am J Psychiatry* **165**, 969-77.
- Berent-Spillson, A., Persad, C., Love, T., Sowers, M., Randolph, J., Zubieta, J. & Smith, Y.** (2012). Hormonal Environment Affects Cognition Independent of Age during the Menopause Transition. *J. Clin. Endocrinol. Metab.* **97**, E1686-E1694.
- Bethea, C. L., Lu, N. Z., Gundlach, C. & Streicher, J. M.** (2002). Diverse actions of ovarian steroids in the serotonin neural system. *Front Neuroendocrinol* **23**, 41-100.
- Bethea, C. L., Mirkes, S. J., Shively, C. A. & Adams, M. R.** (2000). Steroid regulation of tryptophan hydroxylase protein in the dorsal raphe of macaques. *Biol Psychiatry* **47**, 562-76.
- Binder, E. F., Schechtman, K. B., Birge, S. J., Williams, D. B. & Kohrt, W. M.** (2001). Effects of hormone replacement therapy on cognitive performance in elderly women. *Maturitas* **38**, 137-146.
- Bistricky, S. L., Ingram, R. E. & Atchley, R. A.** (2011). Facial affect processing and depression susceptibility: cognitive biases and cognitive neuroscience. *Psychol Bull* **137**, 998-1028.
- Blakely, R. D., De Felice, L. J. & Hartzell, H. C.** (1994). Molecular physiology of norepinephrine and serotonin transporters. *J Exp Biol* **196**, 263-81.
- Caspi, A., Sugden, K., Moffitt, T. E., Taylor, A., Craig, I. W., Harrington, H., McClay, J., Mill, J., Martin, J., Braithwaite, A. & Poulton, R.** (2003). Influence of life stress on depression: moderation by a polymorphism in the 5-HTT gene. *Science* **301**, 386-9.
- Chakraborti, A., Gulati, K. & Ray, A.** (2007). Estrogen Actions on Brain and Behavior: Recent Insights and Future Challenges. In *Rev Neurosci*, p. 395.

- Cohen, S., Kamarck, T. & Mermelstein, R.** (1983). A global measure of perceived stress. *J Health Soc Behav* **24**, 385-96.
- Comasco, E., Frøkjær, V. G. & Sundström Poromaa, I.** (2014). Functional and molecular neuroimaging of menopause and hormone replacement therapy. *Frontiers in Neuroscience* **8**, 1-22.
- Comtat, C., Sureau, F. C., Sibomana, M., Hong, I. K., Sjöholm, N. & Trebossen, R.** (2008). Image based resolution modeling for the HRRT OSEM reconstructions software. In *Nuclear Science Symposium Conference Record, 2008*, pp. 4120-4123.
- Costa, P. T., Jr. & McCrae, R. R.** (1995). Domains and facets: hierarchical personality assessment using the revised NEO personality inventory. *J Pers Assess* **64**, 21-50.
- Costa, P. T., Jr. & McCrae, R. R.** (1997). Stability and change in personality assessment: the revised NEO Personality Inventory in the year 2000. *J Pers Assess* **68**, 86-94.
- Costa, P. T. & McCrae, R. R.** (1992). *Professional Manual for Revised NEO Personality Inventory*. Psychological Assessment Resources: Odessa, Florida.
- Craig, M. C., Fletcher, P. C., Daly, E., Rymer, J., Brammer, M., Giampietro, V. & Murphy, D.** (2008a). Physiological variation in estradiol and brain function: A functional magnetic resonance imaging study of verbal memory across the follicular phase of the menstrual cycle. *Horm. Behav.* **53**, 503-508.
- Craig, M. C., Fletcher, P. C., Daly, E. M., Rymer, J., Brammer, M., Giampietro, V., Maki, P. M. & Murphy, D. G. M.** (2008b). Reversibility of the effects of acute ovarian hormone suppression on verbal memory and prefrontal function in pre-menopausal women. *Psychoneuroendocrinology* **33**, 1426.
- Craig, M. C., Fletcher, P. C., Daly, E. M., Rymer, J., Cutter, W. J., Brammer, M., Giampietro, V., Wickham, H., Maki, P. M. & Murphy, D. G. M.** (2007). Gonadotropin hormone releasing hormone agonists alter prefrontal function during verbal encoding in young women. *Psychoneuroendocrinology* **32**, 1116.
- Crawley, R., Grant, S. & Hinshaw, K.** (2008). Cognitive changes in pregnancy: mild decline or societal stereotype? *Applied Cognitive Psychology* **22**, 1142-1162.
- Crawley, R. A., Dennison, K. & Carter, C.** (2003). Cognition in pregnancy and the first year post - partum. *Psychology and Psychotherapy: Theory, Research and Practice* **76**, 69-84.
- Cronbach, L. J.** (1951). Coefficient alpha and the internal structure of tests. *Psychometrika* **16**, 297-334.
- Dalgleish, T.** (2004). The emotional brain. *Nat Rev Neurosci* **5**, 583-589.
- de Groot, R. H., Hornstra, G., Roozendaal, N. & Jolles, J.** (2003). Memory performance, but not information processing speed, may be reduced during early pregnancy. *J Clin Exp Neuropsychol* **25**, 482-8.
- de Groot, R. H., Vuurman, E. F., Hornstra, G. & Jolles, J.** (2006). Differences in cognitive performance during pregnancy and early motherhood. *Psychol Med* **36**, 1023-32.
- De Gucht, V. & Heiser, W.** (2003). Alexithymia and somatisation: A quantitative review of the literature. *J Psychosom Res* **54**, 425-434.
- Deecher, D., Andree, T. H., Sloan, D. & Schechter, L. E.** (2008). From menarche to menopause: Exploring the underlying biology of depression in women experiencing hormonal changes. *Psychoneuroendocrinology* **33**, 3-17.
- Dimmock, P. W., Wyatt, K. M., Jones, P. W. & O'Brien, P. M. S.** (2000). Efficacy of selective serotonin-reuptake inhibitors in premenstrual syndrome: a systematic review. *The Lancet* **356**, 1131-1136.
- Drake, E. B., Henderson, V. W., Stanczyk, F. Z., McCleary, C. A., Brown, W. S., Smith, C. A., Rizzo, A. A., Murdock, G. A. & Buckwalter, J. G.** (2000). Associations between circulating sex steroid hormones and cognition in normal elderly women. *Neurology* **54**, 599.

- Duddu, V., Isaac, M. K. & Chaturvedi, S. K.** (2003). Alexithymia in somatoform and depressive disorders. *J Psychosom Res* **54**, 435-438.
- Duff, S. J. & Hampson, E.** (2000). A beneficial effect of estrogen on working memory in postmenopausal women taking hormone replacement therapy. *Horm. Behav.* **38**, 262-276.
- Dunkin, J., Rasgon, N., Wagner-Steh, K., David, S., Altshuler, L. & Rapkin, A.** (2005). Reproductive events modify the effects of estrogen replacement therapy on cognition in healthy postmenopausal women. *Psychoneuroendocrinology* **30**, 284-296.
- Eglen, R. M., Wong, E. H. F., Dumuis, A. & Bockaert, J.** (1995). Central 5-HT₄ receptors. *Trends Pharmacol Sci* **16**, 391-398.
- Einstein, G.** (2007). Sex and the Brain. (ed. G. Einstein). MIT press.
- Elliott, R., Rubinsztein, J. S., Sahakian, B. J. & Dolan, R. J.** (2002). The neural basis of mood-congruent processing biases in depression. *Arch Gen Psychiatry* **59**, 597-604.
- Elliott, R., Zahn, R., Deakin, J. F. W. & Anderson, I. M.** (2011). Affective Cognition and its Disruption in Mood Disorders. *Neuropsychopharmacology* **36**, 153-182.
- Emons, G., Grundker, C., Gunthert, A. R., Westphalen, S., Kavanagh, J. & Verschraegen, C.** (2003). GnRH antagonists in the treatment of gynecological and breast cancers. *Endocr Relat Cancer* **10**, 291-9.
- Epperson, C. N., Amin, Z., Ruparel, K., Gur, R. & Loughead, J.** (2012). Interactive effects of estrogen and serotonin on brain activation during working memory and affective processing in menopausal women. *Psychoneuroendocrinology* **37**, 372-82.
- Espeland, M. A., Shumaker, S. A., Leng, I., Manson, J., Brown, C. M., Leblanc, E., Vaughan, L., Robinson, J., Rapp, Sr., Goveas, J., Lane, D., Wactawski-Wende, J., Stefanick, M., Li, W. & Resnick, S. M.** (2013). Long-Term Effects on Cognitive Function of Postmenopausal Hormone Therapy Prescribed to Women Aged 50 to 55 Years. *JAMA Intern. Med.* **173**, 1429-1436.
- Evans, J., Melotti, R., Heron, J., Ramchandani, P., Wiles, N., Murray, L. & Stein, A.** (2012). The timing of maternal depressive symptoms and child cognitive development: a longitudinal study. *J Child Psychol Psychiatry* **53**, 632-40.
- Everaerd, D., Klumpers, F., van Wingen, G., Tendolkar, I. & Fernandez, G.** (2015). Association between neuroticism and amygdala responsivity emerges under stressful conditions. *Neuroimage* **112**, 218-24.
- Ewen, R.** (2010). An Introduction to Theories of Personality. Taylor & Francis Ltd
- Farrag, A.-k. F., Khedr, E. M., Abdel-Aleem, H. & Rageh, T. A.** (2002). Effect of Surgical Menopause on Cognitive Functions. *Dementia and Geriatric Cognitive Disorders* **13**, 193-198.
- File, S., Heard, J. & Rymer, J.** (2002). Trough oestradiol levels associated with cognitive impairment in post-menopausal women after 10 years of oestradiol implants. *Psychopharmacology* **161**, 107-112.
- Fink, G., Sumner, B. E., McQueen, J. K., Wilson, H. & Rosie, R.** (1998). Sex steroid control of mood, mental state and memory. *Clin Exp Pharmacol Physiol* **25**, 764-75.
- Fink, G., Sumner, B. E., Rosie, R., Grace, O. & Quinn, J. P.** (1996). Estrogen control of central neurotransmission: effect on mood, mental state, and memory. *Cell Mol Neurobiol* **16**, 325-44.
- Freeman, E. W., Sammel, M. D., Boorman, D. W. & Zhang, R.** (2014). Longitudinal pattern of depressive symptoms around natural menopause. *JAMA Psychiatry* **71**, 36-43.
- Freeman, E. W., Sammel, M. D., Lin, H. & Nelson, D. B.** (2006). Associations of hormones and menopausal status with depressed mood in women with no history of depression. *Arch Gen Psychiatry* **63**, 375-382.
- Frokjaer, V. G., Erritzoe, D., Juul, A., Nielsen, F. A., Holst, K., Svarer, C., Madsen, J., Paulson, O. B. & Knudsen, G. M.** (2010). Endogenous plasma estradiol in healthy men is

positively correlated with cerebral cortical serotonin 2A receptor binding. *Psychoneuroendocrinology* **35**, 1311-20.

Frokjaer, V. G., Pinborg, A., Holst, K. K., Overgaard, A., Henningsson, S., Heede, M., Larsen, E. C., Jensen, P. S., Agn, M., Nielsen, A. P., Stenbaek, D. S., da Cunha-Bang, S., Lehel, S., Siebner, H. R., Mikkelsen, J. D., Svarer, C. & Knudsen, G. M. (2015). Role of Serotonin Transporter Changes in Depressive Responses to Sex-Steroid Hormone Manipulation: A Positron Emission Tomography Study. *Biol Psychiatry*.

Fuh, J. L., Wang, S. J., Lee, S. J., Lu, S. R. & Juang, K. D. (2006). A longitudinal study of cognition change during early menopausal transition in a rural community. *Maturitas* **53**, 447-453.

Fuh, J. L., Wang, S. J., Lu, S. R., Juang, K. D. & Lee, S. J. (2003). Alterations in cognitive function during the menopausal transition. *Journal of the American Geriatrics Society* **51**, 431-432.

Gavin, N. I., Gaynes, B. N., Lohr, K. N., Meltzer-Brody, S., Gartlehner, G. & Swinson, T. (2005). Perinatal depression: a systematic review of prevalence and incidence. *Obstet Gynecol* **106**, 1071-83.

Gee, A. D., Martarello, L., Passchier, J., Wishart, M., Parker, C., Matthews, J., Comley, R., Hopper, R. & Gunn, R. (2008). Synthesis and Evaluation of [¹¹C]SB207145 as the First In Vivo Serotonin 5-HT₄ Receptor Radioligand for PET Imaging in Man. *Current Radiopharmaceuticals* **1**, 110-114.

Gilbert, P. (2004). Depression: A Biopsychosocial, Integrative, and Evolutionary Approach. In *Mood Disorders: A Handbook of Science and Practice* (ed. M. Power). John Wiley & Sons Ltd.

Glynn, L. M. (2010). Giving birth to a new brain: hormone exposures of pregnancy influence human memory. *Psychoneuroendocrinology* **35**, 1148-55.

Glynn, L. M. (2012). Increasing parity is associated with cumulative effects on memory. *Journal of women's health (2002)* **21**, 1038.

Gogos, A., Wu, Y. C., Williams, A. S. & Byrne, L. K. (2014). The effects of ethinylestradiol and progestins ("the pill") on cognitive function in pre-menopausal women. *Neurochem Res* **39**, 2288-300.

Goodman, S. H., Rouse, M. H., Connell, A. M., Broth, M. R., Hall, C. M. & Heyward, D. (2011). Maternal depression and child psychopathology: a meta-analytic review. *Clin Child Fam Psychol Rev* **14**, 1-27.

Gorenstein, C., Renno, J., Vieira, A., Gianfaldoni, A., Goncalves, M. A., Halbe, H., Fernandes, C. E. & Demetrio, F. (2011). Estrogen replacement therapy and cognitive functions in healthy postmenopausal women: a randomized trial. *Arch. Womens Ment. Health* **14**, 367-373.

Greendale, G., Huang, M., Wight, R. G., Seeman, T., Luetters, C., Avis, N., Johnston, J. & Karlamangla, A. (2009). Effects of the menopause transition and hormone use on cognitive performance in midlife women. *Neurology* **72**, 1850-1857.

Grigороva, M., Sherwin, B. B. & Tulandi, T. (2006). Effects of treatment with leuprolide acetate depot on working memory and executive functions in young premenopausal women. *Psychoneuroendocrinology* **31**, 935-947.

Gundlah, C., Lu, N. Z. & Bethea, C. L. (2002). Ovarian steroid regulation of monoamine oxidase-A and -B mRNAs in the macaque dorsal raphe and hypothalamic nuclei. *Psychopharmacology (Berl)* **160**, 271-82.

Harlow, S. D., Gass, M., Hall, J. E., Lobo, R., Maki, P., Rebar, R. W., Sherman, S., Sluss, P. M. & de Villiers, T. J. (2012). Executive summary of the Stages of Reproductive Aging Workshop + 10: addressing the unfinished agenda of staging reproductive aging. *J Clin Endocrinol Metab* **97**, 1159-68.

- Hasin, D. S., Goodwin, R. D., Stinson, F. S. & Grant, B. F.** (2005). Epidemiology of major depressive disorder: Results from the national epidemiologic survey on alcoholism and related conditions. *Arch Gen Psychiatry* **62**, 1097-1106.
- Hatta, T. & Nagaya, K.** (2009). Menstrual Cycle Phase Effects on Memory and Stroop Task Performance. *The Official Publication of the International Academy of Sex Research* **38**, 821-827.
- Henderson, J. A. & Bethea, C. L.** (2008). Differential effects of ovarian steroids and raloxifene on serotonin 1A and 2C receptor protein expression in macaques. *Endocrine* **33**, 285-93.
- Henderson, V. W., Guthrie, J. R., Dudley, E. C., Burger, H. G. & Dennerstein, L.** (2003). Estrogen exposures and memory at midlife: a population-based study of women. *Neurology* **60**, 1369.
- Henderson, V. W. & Sherwin, B. B.** (2007). Surgical versus natural menopause: cognitive issues. *Menopause* **14**, 572-9.
- Henry, J. D. & Rendell, P. G.** (2007). A review of the impact of pregnancy on memory function. *J Clin Exp Neuropsychol* **29**, 793-803.
- Henry, J. F. & Sherwin, B. B.** (2012). Hormones and Cognitive Functioning During Late Pregnancy and Postpartum: A Longitudinal Study. *Behavioral Neuroscience* **126**, 73-85.
- Herlitz, A., Thilers, P. & Habib, R.** (2007). Endogenous estrogen is not associated with cognitive performance before, during, or after menopause. *Menopause-J. N. Am. Menopause Soc.* **14**, 425-431.
- Hogervorst, E. & Bandelow, S.** (2010). Sex steroids to maintain cognitive function in women after the menopause: A meta-analysis of treatment trials. *Maturitas* **66**, 56-71.
- Hogervorst, E., Boshuisen, M., Riedel, W., Willeken, C. & Jolles, J.** (1999). The effect of hormone replacement therapy on cognitive function in elderly women. *Psychoneuroendocrinology* **24**, 43-68.
- Hong, I. K., Chung, S. T., Kim, H. K., Kim, Y. B., Son, Y. D. & Cho, Z. H.** (2007). Ultra Fast Symmetry and SIMD-Based Projection-Backprojection (SSP) Algorithm for 3-D PET Image Reconstruction. *Medical Imaging, IEEE Transactions on* **26**, 789-803.
- Houle, S., Ginovart, N., Hussey, D., Meyer, J. H. & Wilson, A. A.** (2000). Imaging the serotonin transporter with positron emission tomography: initial human studies with [¹¹C]DAPP and [¹¹C]DASB. *Eur J Nucl Med* **27**, 1719-22.
- Hoyt, L. T. & Falconi, A. M.** (2015). Puberty and perimenopause: Reproductive transitions and their implications for women's health. *Social Science & Medicine* **132**, 103-112.
- Haahr, M. E., Fisher, P., Holst, K., Madsen, K., Jensen, C. G., Marner, L., Lehel, S., Baaré, W., Knudsen, G. & Hasselbalch, S.** (2013). The 5-HT₄ receptor levels in hippocampus correlates inversely with memory test performance in humans. *Hum Brain Mapp* **34**, 3066-3074.
- Haahr, M. E., Fisher, P. M., Jensen, C. G., Frokjaer, V. G., Mahon, B. M., Madsen, K., Baare, W. F. C., Lehel, S., Norremolle, A., Rabiner, E. A. & Knudsen, G. M.** (2014). Central 5-HT₄ receptor binding as biomarker of serotonergic tone in humans: a [¹¹C]SB207145 PET study. *Mol Psychiatry* **19**, 427-432.
- Innis, R. B., Cunningham, V. J., Delforge, J., Fujita, M., Gjedde, A., Gunn, R. N., Holden, J., Houle, S., Huang, S. C., Ichise, M., Iida, H., Ito, H., Kimura, Y., Koeppe, R. A., Knudsen, G. M., Knuuti, J., Lammertsma, A. A., Laruelle, M., Logan, J., Maguire, R. P., Mintun, M. A., Morris, E. D., Parsey, R., Price, J. C., Slifstein, M., Sossi, V., Suhara, T., Votaw, J. R., Wong, D. F. & Carson, R. E.** (2007). Consensus nomenclature for in vivo imaging of reversibly binding radioligands. *J Cereb Blood Flow Metab* **27**, 1533-1539.
- Jacobs, D. M., Tang, M. X., Stern, Y., Sano, M., Marder, K., Bell, K. L., Schofield, P., Dooneief, G., Gurland, B. & Mayeux, R.** (1998). Cognitive function in nondemented older women who took estrogen after menopause. *Neurology* **50**, 368.

- Jans, L. A. W., Riedel, W. J., Markus, C. R. & Blokland, A.** (2006). Serotonergic vulnerability and depression: assumptions, experimental evidence and implications. *Mol Psychiatry* **12**, 522-543.
- Jensen, C. G., Hjordt, L. V., Stenbæk, D. S., Andersen, E., Back, S. K., Lansner, J., Hageman, I., Dam, H., Porsmose, A., Knudsen, G. M., Frokjaer, V. G. & Hasselbalch, S. G.** (In press). Development and psychometric validation of the verbal affective memory test. *Memory*.
- Joffe, H., Hall, J., Gruber, S., Sarmiento, I., Cohen, L., Yurgelun-Todd, D. & Martin, K.** (2006). Estrogen therapy selectively enhances prefrontal cognitive processes: a randomized, double-blind, placebo-controlled study with functional magnetic resonance imaging in perimenopausal and recently postmenopausal women. *Menopause-J. N. Am. Menopause Soc.* **13**, 411-422.
- Jovanovic, H., Kocoska-Maras, L., Radestad, A. F., Halldin, C., Borg, J., Hirschberg, A. L. & Nordstrom, A. L.** (2015). Effects of estrogen and testosterone treatment on serotonin transporter binding in the brain of surgically postmenopausal women--a PET study. *Neuroimage* **106**, 47-54.
- Kaplan, D.** (2008). Structural Equation Modeling: Foundations and Extensions. SAGE Publications.
- Keller, M. B.** (2000). Citalopram therapy for depression: a review of 10 years of European experience and data from U.S. clinical trials. *J Clin Psychiatry* **61**, 896-908.
- Kessler, R. C., Berglund, P., Demler, O., Jin, R., Merikangas, K. R. & Walters, E. E.** (2005). Lifetime prevalence and age-of-onset distributions of DSM-IV disorders in the national comorbidity survey replication. *Arch Gen Psychiatry* **62**, 593-602.
- Kessler, R. C., McGonagle, K. A., Swartz, M., Blazer, D. G. & Nelson, C. B.** (1993). Sex and depression in the National Comorbidity Survey I: Lifetime prevalence, chronicity and recurrence. *J Affect Disord* **29**, 85-96.
- Kimura, D.** (1995). Estrogen Replacement Therapy May Protect against Intellectual Decline in Postmenopausal Women. *Hormones and Behavior* **29**, 312-321.
- Klein, D. N., Kotov, R. & Bufferd, S. J.** (2011). Personality and depression: explanatory models and review of the evidence. *Annu Rev Clin Psychol* **7**, 269-95.
- Knudsen, G. M., Jensen, P. S., Erritzoe, D., Baare, W. F., Ettrup, A., Fisher, P. M., Gillings, N., Hansen, H. D., Hansen, L. K., Hasselbalch, S. G., Henningsson, S., Herth, M. M., Holst, K. K., Iversen, P., Kessing, L. V., Macoveanu, J., Madsen, K. S., Mortensen, E. L., Nielsen, F. A., Paulson, O. B., Siebner, H. R., Stenbaek, D. S., Svarer, C., Jernigan, T. L., Strother, S. C. & Frokjaer, V. G.** (2015). The Center for Integrated Molecular Brain Imaging (Cimbi) database. *Neuroimage*.
- Kocoska-Maras, L., Zethraeus, N., Radestad, A., Ellingsen, T., Von Schoultz, B., Johannesson, M. & Hirschberg, A. L.** (2011). A randomized trial of the effect of testosterone and estrogen on verbal fluency, verbal memory, and spatial ability in healthy postmenopausal women. *Fertil. Steril.* **95**, 152-157.
- Kritz - Silverstein, D. & Barrett - Connor, E.** (2002). Hysterectomy, Oophorectomy, and Cognitive Function in Older Women. *Journal of the American Geriatrics Society* **50**, 55-61.
- Krug, R., Born, J. & Rasch, B.** (2006). A 3-day estrogen treatment improves prefrontal cortex-dependent cognitive function in postmenopausal women. *Psychoneuroendocrinology* **31**, 965-975.
- Krug, R., Molle, M., Dodt, C., Fehm, H. L. & Born, J.** (2003). Acute influences of estrogen and testosterone on divergent and convergent thinking in postmenopausal women. *Neuropsychopharmacology* **28**, 1538-1545.
- Lamas, C., Chambry, J., Nicolas, I., Frydman, R., Jeammet, P. & Corcos, M.** (2006). Alexithymia in infertile women. *J Psychosom Obstet Gynaecol* **27**, 23-30.
- Le, H. N., Ramos, M. A. & Muñoz, R. F.** (2007). The relationship between alexithymia and perinatal depressive symptomatology. *J Psychosom Res* **62**, 215-222.

- Le Strat, Y., Dubertret, C. & Le Foll, B.** (2011). Prevalence and correlates of major depressive episode in pregnant and postpartum women in the United States. *J Affect Disord* **135**, 128-38.
- LeBlanc, E. S., Janowsky, J., Chan, B. K. & Nelson, H. D.** (2001). Hormone replacement therapy and cognition: systematic review and meta-analysis. *JAMA* **285**, 1489-99.
- Leblanc, S. E., Neiss, B. M., Carello, E. P., Samuels, H. M. & Janowsky, S. J.** (2007). Hot flashes and estrogen therapy do not influence cognition in early menopausal women. *Menopause* **14**, 191-202.
- Licht, C. L., Marcussen, A. B., Wegener, G., Overstreet, D. H., Aznar, S. & Knudsen, G. M.** (2009). The brain 5-HT₄ receptor binding is down-regulated in the Flinders Sensitive Line depression model and in response to paroxetine administration. *J Neurochem* **109**, 1363-1374.
- Linzmayr, L., Semlitsch, H., Saletu, B., Böck, G., Saletu-zyhlarz, G., Zoghalmi, A., Gruber, D., Metka, M., Huber, J., Oettel, M., Gräser, T. & Grünberger, J.** (2001). Double-blind, Placebo-controlled Psychometric Studies on the Effects of a Combined Estrogen-progestin Regimen versus Estrogen Alone on Performance, Mood and Personality of Menopausal Syndrome Patients. *Arzneimittelforschung* **51**, 238-245.
- Lokken, K. L. & Ferraro, F. R.** (2006). The relationship between menopausal status, phase of menstrual cycle, and replacement estrogen on cognition in healthy women without dementia. *The Journal of Psychology* **140**, 533.
- Lokuge, S., Frey, B. N., Foster, J. A., Soares, C. N. & Steiner, M.** (2011). Depression in women: windows of vulnerability and new insights into the link between estrogen and serotonin. *J Clin Psychiatry* **72**, e1563-9.
- Lu, N. Z. & Bethea, C. L.** (2002). Ovarian steroid regulation of 5-HT_{1A} receptor binding and G protein activation in female monkeys. *Neuropsychopharmacology* **27**, 12-24.
- Luetters, C., Huang, M.-H., Seeman, T., Buckwalter, G., Meyer, P. M., Avis, N. E., Sternfeld, B., Johnston, J. M. & Greendale, G. A.** (2007). Menopause Transition Stage and Endogenous Estradiol and Follicle-Stimulating Hormone Levels are Not Related to Cognitive Performance: Cross-Sectional Results from the Study of Women's Health across the Nation (SWAN). *Journal of Women's Health (15409996)* **16**, 331-344.
- Madsen, K., Haahr, M. T., Marnar, L., Keller, S. H., Baare, W. F., Svarer, C., Hasselbalch, S. G. & Knudsen, G. M.** (2011). Age and sex effects on 5-HT₄ receptors in the human brain: a [¹¹C]SB207145 PET study. *J Cereb Blood Flow Metab* **31**, 1475-1481.
- Maki, P. M., Dennerstein, L., Clark, M., Guthrie, J., LaMontagne, P., Fornelli, D., Little, D., Henderson, V. W. & Resnick, S. M.** (2011). Perimenopausal use of hormone therapy is associated with enhanced memory and hippocampal function later in life. *Brain Research* **1379**, 232-243.
- Maki, P. M., Gast, M. J., Vieweg, A. J., Burriss, S. W. & Yaffe, K.** (2007). Hormone therapy in menopausal women with cognitive complaints: a randomized, double-blind trial. *Neurology* **69**, 1322.
- Maki, P. M., Rich, J. B. & Shayna Rosenbaum, R.** (2002). Implicit memory varies across the menstrual cycle: estrogen effects in young women. *Neuropsychologia* **40**, 518-529.
- Maki, P. M. & Sundermann, E.** (2009). Hormone therapy and cognitive function. *Hum Reprod Update* **15**, 667-681.
- Maki, P. M., Zonderman, A. B. & Resnick, S. M.** (2001). Enhanced verbal memory in nondemented elderly women receiving hormone-replacement therapy. *The American journal of psychiatry* **158**, 227.
- Marcus, S. M., Kerber, K. B., Rush, A. J., Wisniewski, S. R., Nierenberg, A., Balasubramani, G. K., Ritz, L., Kornstein, S., Young, E. A. & Trivedi, M. H.** (2008). Sex differences in depression symptoms in treatment-seeking adults: confirmatory analyses from the Sequenced Treatment Alternatives to Relieve Depression study. *Compr Psychiatry* **49**, 238-246.

- Marner, L., Gillings, N., Comley, R. A., Baaré, W. F. C., Rabiner, E. A., Wilson, A. A., Houle, S., Hasselbalch, S. G., Svarer, C., Gunn, R. N., Laruelle, M. & Knudsen, G. M.** (2009). Kinetic Modeling of ¹¹C-SB207145 Binding to 5-HT₄ Receptors in the Human Brain In Vivo. *Journal of Nuclear Medicine* **50**, 900-908.
- Mathews, A. & MacLeod, C.** (2005). Cognitive vulnerability to emotional disorders. *Annu Rev Clin Psychol* **1**, 167-95.
- McCrae, R. R. & Costa, P. T.** (2003). *Personality in adulthood : a five-factor theory perspective*. Guilford Press: New York.
- McEwen, B. S.** (2002). Estrogen actions throughout the brain. *Recent Prog Horm Res* **57**, 357-84.
- McEwen, B. S.** (1994). Steroid hormone actions on the brain: when is the genome involved? *Horm Behav* **28**, 396-405.
- McEwen, B. S.** (2001). Invited review: Estrogens effects on the brain: multiple sites and molecular mechanisms. *J Appl Physiol (1985)* **91**, 2785-801.
- McEwen, B. S., Akama, K. T., Spencer-Segal, J. L., Milner, T. A. & Waters, E. M.** (2012). Estrogen effects on the brain: Actions beyond the hypothalamus via novel mechanisms. *Behav Neurosci* **126**, 4-16.
- Mendelsohn, D., Riedel, W. J. & Sambeth, A.** (2009). Effects of acute tryptophan depletion on memory, attention and executive functions: A systematic review. *Neuroscience & Biobehavioral Reviews* **33**, 926-952.
- Messinis, L., Vlahou, C., Tsapanos, V., Tsapanos, A., Spilioti, D. & Papathanasopoulos, P.** (2010). Neuropsychological functioning in postpartum depressed versus nondepressed females and nonpostpartum controls. *J. Clin. Exp. Neuropsychol.* **32**, 661-666.
- Millar, R. P., Lu, Z.-L., Pawson, A. J., Flanagan, C. A., Morgan, K. & Maudsley, S. R.** (2004). Gonadotropin-Releasing Hormone Receptors. *Endocrine Reviews* **25**, 235-275.
- Miskowiak, K. W. & Carvalho, A. F.** (2014). 'Hot' cognition in major depressive disorder: a systematic review. *CNS Neurol Disord Drug Targets* **13**, 1787-803.
- Moller, M. C., Bartfai, A. B. & Radestad, A.** (2010). Effects of testosterone and estrogen replacement on memory function. *Menopause-J. N. Am. Menopause Soc.* **17**, 983-989.
- Mordecai, K. L., Rubin, L. H. & Maki, P. M.** (2008). Effects of menstrual cycle phase and oral contraceptive use on verbal memory. *Hormones and Behavior* **54**, 286-293.
- Morilak, D. A. & Frazer, A.** (2004). Antidepressants and brain monoaminergic systems: a dimensional approach to understanding their behavioural effects in depression and anxiety disorders. *The International Journal of Neuropsychopharmacology* **7**, 193-218.
- Moussavi, S., Chatterji, S., Verdes, E., Tandon, A., Patel, V. & Ustun, B.** (2007). Depression, chronic diseases, and decrements in health: results from the World Health Surveys. *The Lancet* **370**, 851-858.
- Munk-Olsen, T., Laursen, T. M., Pedersen, C. B., Mors, O. & Mortensen, P. B.** (2006). New parents and mental disorders: a population-based register study. *JAMA* **296**, 2582-9.
- Müller, C. & Jacobs, B.** (2010). *Handbook of the behavioral neurobiology of serotonin*. Academic Press.
- Nappi, R. E., Sinforiani, E., Mauri, M., Bono, G., Polatti, F. & Nappi, G.** (1999). Memory Functioning at Menopause: Impact of Age in Ovariectomized Women. *Gynecologic and Obstetric Investigation* **47**, 29-36.
- Nott, P. N., Franklin, M., Armitage, C. & Gelder, M. G.** (1976). Hormonal changes and mood in the puerperium. *Br J Psychiatry* **128**, 379-83.
- O'Hara, M., Swain, AM** (1996). Rates and risk of postpartum depression- a meta-analysis. *Int Rev Psychiatry* **8**, 37-54.

- O'Hara, M. W., Schlechte, J. A., Lewis, D. A. & Wright, E. J.** (1991). Prospective study of postpartum blues. Biologic and psychosocial factors. *Arch Gen Psychiatry* **48**, 801-6.
- Olivier, B.** (2015). Serotonin: A never-ending story. *Eur J Pharmacol* **753**, 2-18.
- Olsen, L. R., Mortensen, E. L. & Bech, P.** (2006). Mental distress in the Danish general population. *Acta Psychiatr Scand* **113**, 477-84.
- Onyper, S. V., Searleman, A., Thacher, P., Maine, E. E. & Johnson, A. G.** (2010). Executive functioning and general cognitive ability in pregnant women and matched controls. *J. Clin. Exp. Neuropsychol.* **32**, 986-995.
- Ormel, J. & Silva, C. E.** (1995). The impact of psychopathology on disability and health perceptions. In *Mental Illness in General Health Care*. John Wiley & Sons Ltd.
- Ormel, J., Vonkorff, M., Oldehinkel, A. J., Simon, G., Tiemens, B. G., Uuml, St & N, T. B.** (1999). Onset of disability in depressed and non-depressed primary care patients. *Psychol Med* **29**, 847-853.
- Owens, J., Matthews, K. & Everson, S. A.** (2002). Cognitive function effects of suppressing ovarian hormones in young women. *Menopause-J. N. Am. Menopause Soc.* **9**, 227-235.
- Paul, S. M. & Purdy, R. H.** (1992). Neuroactive steroids. *FASEB J* **6**, 2311-22.
- Pearson, R. M., Evans, J., Kounali, D., Lewis, G., Heron, J., Ramchandani, P. G., O'Connor, T. G. & Stein, A.** (2013). Maternal depression during pregnancy and the postnatal period: risks and possible mechanisms for offspring depression at age 18 years. *JAMA Psychiatry* **70**, 1312-9.
- Pearson, R. M., Heron, J., Melotti, R., Joinson, C., Stein, A., Ramchandani, P. G. & Evans, J.** (2011). The association between observed non-verbal maternal responses at 12 months and later infant development at 18 months and IQ at 4 years: a longitudinal study. *Infant Behav Dev* **34**, 525-33.
- Pefanco, M. A., Kenny, A. M., Kaplan, R. F., Kuchel, G., Walsh, S., Kleppinger, A. & Prestwood, K.** (2007). The effect of 3-year treatment with 0.25 mg/day of micronized 17beta-estradiol on cognitive function in older postmenopausal women. *Journal of the American Geriatrics Society* **55**, 426.
- Persad, C. C., Zubieta, J.-K., Love, T., Wang, H., Tkaczyk, A. & Smith, Y. R.** (2009). Enhanced neuroactivation during verbal memory processing in postmenopausal women receiving short-term hormone therapy. *Fertility and sterility* **92**, 197.
- Phillips, S. M. & Sherwin, B. B.** (1992). Effects of estrogen on memory function in surgically menopausal women. *Psychoneuroendocrinology* **17**, 485-495.
- Piccinelli, M. & Wilkinson, G.** (2000). *Gender differences in depression*.
- Pini, S., de Queiroz, V., Pagnin, D., Pezawas, L., Angst, J., Cassano, G. B. & Wittchen, H.-U.** (2005). Prevalence and burden of bipolar disorders in European countries. *European Neuropsychopharmacology* **15**, 425-434.
- Polo-Kantola, P., Portin, R., Polo, O., Helenius, H., Irjala, K. & Erkkola, R.** (1998). The Effect of Short-Term Estrogen Replacement Therapy on Cognition: A Randomized, Double-Blind, Cross-Over Trial in Postmenopausal Women. *Obstetrics & Gynecology* **91**, 459-466.
- Resnick, M. S., Maki, M. P., Rapp, R. S., Espeland, A. M., Brunner, H. R., Coker, A. L., Granek, K. I., Hogan, A. P., Ockene, A. J. & Shumaker, A. S.** (2006). Effects of Combination Estrogen Plus Progestin Hormone Treatment on Cognition and Affect. *The Journal of Clinical Endocrinology & Metabolism* **91**, 1802-1810.
- Resnick, S. M., Espeland, M. A., An, Y., Maki, P., Coker, L. H., Jackson, R., Stefanick, M., Wallace, R. & Rapp, Sr.** (2009). Effects of Conjugated Equine Estrogens on Cognition and Affect in Postmenopausal Women with Prior Hysterectomy. *J. Clin. Endocrinol. Metab.* **94**, 4152-4161.
- Resnick, S. M. & Maki, P. M.** (2001). Effects of Hormone Replacement Therapy on Cognitive and Brain Aging. *Annals of the New York Academy of Sciences* **949**, 203-214.

- Resnick, S. M., Maki, P. M., Golski, S., Kraut, M. A. & Zonderman, A. B.** (1998). Effects of Estrogen Replacement Therapy on PET Cerebral Blood Flow and Neuropsychological Performance. *Hormones and Behavior* **34**, 171-182.
- Rosenberg, L. & Park, S.** (2002). Verbal and spatial functions across the menstrual cycle in healthy young women. *Psychoneuroendocrinology* **27**, 835-841.
- Ryan, J., Carrière, I., Scali, J., Dartigues, J. F., Tzourio, C., Poncet, M., Ritchie, K. & Ancelin, M. L.** (2009). Characteristics of hormone therapy, cognitive function, and dementia: the prospective 3C Study. *Neurology* **73**, 1729.
- Schiff, R., Bulpitt, C. J., Wesnes, K. A. & Rajkumar, C.** (2005). Short-term transdermal estradiol therapy, cognition and depressive symptoms in healthy older women. A randomised placebo controlled pilot cross-over study. *Psychoneuroendocrinology* **30**, 309-15.
- Schmidt, P., Keenan, P., Schenkel, L., Berlin, K., Gibson, C. & Rubinow, D.** (2013). Cognitive performance in healthy women during induced hypogonadism and ovarian steroid addback. *Official Journal of the Section on Women's Health of the World Psychiatric Association* **16**, 47-58.
- Schaafsma, M., Homewood, J. & Taylor, A.** (2010). Subjective cognitive complaints at menopause associated with declines in performance of verbal memory and attentional processes. *Climacteric* **13**, 84-98.
- Shaywitz, S., Naftolin, F., Zelterman, D., Marchione, K., Holahan, J., Palter, S. & Shaywitz, B. A.** (2003). Better oral reading and short-term memory in midlife, postmenopausal women taking estrogen. *Menopause-J. N. Am. Menopause Soc.* **10**, 420-426.
- Shaywitz, S. E., Shaywitz, B. A., Pugh, K. R., Fulbright, R. K., Skudlarski, P., Mencl, W. E., Constable, R. T., Naftolin, F., Palter, S. F., Marchione, K. E., Katz, L., Shankweiler, D. P., Fletcher, J. M., Lacadie, C., Keltz, M. & Gore, J. C.** (1999). Effect of estrogen on brain activation patterns in postmenopausal women during working memory tasks. *JAMA* **281**, 1197.
- Sherman, B. M. & Korenman, S. G.** (1975). Hormonal characteristics of the human menstrual cycle throughout reproductive life. *J Clin Invest* **55**, 699-706.
- Sherwin, B. B.** (1988). Estrogen and/or androgen replacement therapy and cognitive functioning in surgically menopausal women. *Psychoneuroendocrinology* **13**, 345-357.
- Sherwin, B. B.** (1994). Estrogenic effects on memory in women. *Ann N Y Acad Sci* **743**, 213-30; discussion 230-1.
- Sherwin, B. B.** (1998). Estrogen and cognitive functioning in women. *Proc Soc Exp Biol Med* **217**, 17-22.
- Sherwin, B. B.** (2005). Surgical menopause, estrogen, and cognitive function in women: what do the findings tell us? *Ann N Y Acad Sci* **1052**, 3-10.
- Sherwin, B. B.** (2009). Estrogen therapy: is time of initiation critical for neuroprotection? *Nat Rev Endocrinol* **5**, 620-627.
- Sherwin, B. B.** (2012). Estrogen and cognitive functioning in women: lessons we have learned. *Behav Neurosci* **126**, 123-7.
- Silber, B. Y. & Schmitt, J. A. J.** (2010). Effects of tryptophan loading on human cognition, mood, and sleep. *Neuroscience & Biobehavioral Reviews* **34**, 387-407.
- Skovdahl Hansen, H., Mortensen, E. L. & Schiøtz, H. K.** (2003). *NEO PI-R. Manual - clinical. Danish version.* Dansk Psykologisk Forlag: Copenhagen.
- Speroff, L. & Fritz, M.** (2005). *Clinical Gynecologic Endocrinology and Infertility.* Lippincott Williams And Wilkins.
- Stein, A., Malmberg, L. E., Sylva, K., Barnes, J. & Leach, P.** (2008). The influence of maternal depression, caregiving, and socioeconomic status in the post-natal year on children's language development. *Child Care Health Dev* **34**, 603-12.

- Suda, S., Segi-Nishida, E., Newton, S. S. & Duman, R. S.** (2008). A postpartum model in rat: behavioral and gene expression changes induced by ovarian steroid deprivation. *Biol Psychiatry* **64**, 311-9.
- Sundström-Poromaa, I. S. & Gingnell, M.** (2014). Menstrual cycle influence on cognitive function and emotion processing - from the reproductive perspective. *Frontiers in Neuroscience* **8**.
- Sureau, F. C., Reader, A. J., Comtat, C., Leroy, C., Ribeiro, M.-J., Buvat, I. & Trébossen, R.** (2008). Impact of Image-Space Resolution Modeling for Studies with the High-Resolution Research Tomograph. *Journal of Nuclear Medicine* **49**, 1000-1008.
- Svarer, C., Madsen, K., Hasselbalch, S. G., Pinborg, L. H., Haugbøl, S., Frøkjær, V. G., Holm, S., Paulson, O. B. & Knudsen, G. M.** (2005). MR-based automatic delineation of volumes of interest in human brain PET images using probability maps. *Neuroimage* **24**, 969-979.
- Team, R. C.** (2013). *R: A language and environment for statistical computing*. R Foundation for Statistical Computing: Vienna, Austria.
- Thomas, E. J., Jenkins, J., Lenton, E. A. & Cooke, I. D.** (1986). Endocrine effects of goserelin, a new depot luteinising hormone releasing hormone agonist. *Br Med J (Clin Res Ed)* **293**, 1407-8.
- Tierney, M. C., Oh, P., Moineddin, R., Greenblatt, E. M., Snow, W. G., Fisher, R. H., Iazzetta, J., Hyslop, P. S. G. & Maclusky, N. J.** (2009). A randomized double-blind trial of the effects of hormone therapy on delayed verbal recall in older women. *Psychoneuroendocrinology* **34**, 1065.
- Toffoletto, S., Lanzenberger, R., Gingnell, M., Sundström-Poromaa, I. & Comasco, E.** (2014). Emotional and cognitive functional imaging of estrogen and progesterone effects in the female human brain: A systematic review. *Psychoneuroendocrinology* **50**, 28-52.
- Varnas, K., Halldin, C. & Hall, H.** (2004). Autoradiographic distribution of serotonin transporters and receptor subtypes in human brain. *Hum Brain Mapp* **22**, 246-60.
- Varnas, K., Halldin, C., Pike, V. W. & Hall, H.** (2003). Distribution of 5-HT₄ receptors in the postmortem human brain - an autoradiographic study using [¹²⁵I]SB 207710. *Eur Neuropsychopharmacol* **13**, 228-34.
- Verghese, J., Kuslansky, G., Katz, M. J., Sliwinski, M., Crystal, H. A., Buschke, H. & Lipton, R. B.** (2000). Cognitive performance in surgically menopausal women on estrogen. *Neurology* **55**, 872.
- Weber, M., Rubin, L. H. & Maki, P.** (2013). Cognition in perimenopause: the effect of transition stage. *Menopause-J. N. Am. Menopause Soc.* **20**, 511-517.
- Weber, M. T., Maki, P. M. & McDermott, M. P.** (2014). Cognition and mood in perimenopause: a systematic review and meta-analysis. *J Steroid Biochem Mol Biol* **142**, 90-8.
- Wegesin, D. & Stern, Y.** (2007). Effects of Hormone Replacement Therapy and Aging on Cognition: Evidence for Executive Dysfunction. *Aging, Neuropsychology, and Cognition* **14**, 301-328.
- Weightman, M. J., Air, T. M. & Baune, B. T.** (2014). A review of the role of social cognition in major depressive disorder. *Front Psychiatry* **5**, 179.
- Weiss, G., Skurnick, J. H., Goldsmith, L. T., Santoro, N. F. & Park, S. J.** (2004). Menopause and hypothalamic-pituitary sensitivity to estrogen. *JAMA* **292**, 2991-2996.
- WHO** (2005). International Classification of Diseases, 10th Revision (ICD-10). Geneva, Switzerland.
- Wilson, D. L., Barnes, M., Ellett, L., Permezel, M., Jackson, M. & Crowe, S. F.** (2011). Compromised verbal episodic memory with intact visual and procedural memory during pregnancy. *Journal of Clinical and Experimental Neuropsychology* **33**, 680-691.
- Wolf, O. T., Heinrich, A. B., Hanstein, B. & Kirschbaum, C.** (2005). Estradiol or estradiol/progesterone treatment in older women: no strong effects on cognition. *Neurobiology of Aging* **26**, 1029-1033.

- Wolf, O. T. & Kirschbaum, C.** (2002). Endogenous Estradiol and Testosterone Levels Are Associated with Cognitive Performance in Older Women and Men. *Hormones and Behavior* **41**, 259-266.
- Wolf, O. T., Kudielka, B. M., Hellhammer, D., Torber, S., McEwen, B. S. & Kirschbaum, C.** (1999). Two weeks of transdermal estradiol treatment in postmenopausal elderly women and its effect on memory and mood: verbal memory changes are associated with the treatment induced estradiol levels. *Psychoneuroendocrinology* **24**, 727-741.
- Woolie, T., Kenna, H., Williams, K., Powers, B., Holcomb, M., Khaylis, A. & Rasgon, N.** (2011). Differences in Verbal Memory Performance in Postmenopausal Women Receiving Hormone Therapy: 17 beta-Estradiol Versus Conjugated Equine Estrogens. *Am. J. Geriatr. Psychiatr.* **19**, 792-802.
- Yaffe, K., Vittinghoff, E., Ensrud, K. E., Johnson, K. C., Diem, S., Hanes, V. & Grady, D.** (2006). Effects of ultra-low-dose transdermal estradiol on cognition and health-related quality of life. *Archives of neurology* **63**, 945.
- Yonker, J., Adolfsson, R., Eriksson, E., Hellstrand, M., Nilsson, L.-G. & Herlitz, A.** (2006). Verified Hormone Therapy Improves Episodic Memory Performance in Healthy Postmenopausal Women. *Aging, Neuropsychology, and Cognition* **13**, 291-307.

APPENDICES

Paper 1: Mental distress and personality in women undergoing GnRH antagonist versus GnRH agonist protocols for assisted reproductive technology

Paper 2: Cerebral serotonin 4 receptor binding inversely associated with affective memory in healthy volunteers

Paper 3: Transient sex-steroid hormone manipulation slows reaction time and increases mood variability but does not affect verbal memory in young healthy women

PAPER 1

Mental distress and personality in women undergoing GnRH agonist versus GnRH antagonist protocols for assisted reproductive technology

D.S. Stenbæk¹, M. Toftager², L.V. Hjordt¹, P.S. Jensen¹,
K.K. Holst^{1,3}, T. Bryndorf², T. Holland², J. Bogstad², A. Pinborg²,
P. Hornnes², and V.G. Frokjaer^{1,*}

¹Neurobiology Research Unit, Copenhagen University Hospital and Center for Integrated Molecular Brain Imaging, Copenhagen, Denmark
²Hvidovre University Hospital, Fertility Clinic, Copenhagen, Denmark ³Department of Biostatistics, University of Copenhagen, Copenhagen, Denmark

*Correspondence address: vibe@nru.dk

Submitted on June 26, 2014; resubmitted on October 1, 2014; accepted on October 15, 2014

STUDY QUESTION: Do mental distress and mood fluctuations in women undergoing GnRH agonist and GnRH antagonist protocols for assisted reproductive technology (ART) differ depending on protocol and the personality trait, neuroticism?

SUMMARY ANSWER: ART treatment did not induce elevated levels of mental distress in either GnRH antagonist or agonist protocols but neuroticism was positively associated with increased mental distress, independent of protocols.

WHAT IS KNOWN ALREADY: ART treatment may increase mental distress by mechanisms linked to sex hormone fluctuations. General psychological characteristics, such as personality traits indexing negative emotionality, e.g. neuroticism, are likely to affect mental distress during ART treatment.

STUDY DESIGN, SIZE, DURATION: A total of 83 women undergoing their first ART cycle were consecutively randomized 1:1 to GnRH antagonist ($n = 42$) or GnRH agonist ($n = 41$) protocol. The study population was a subgroup of a larger ongoing Danish clinical randomized trial and was established as an add-on in the period 2010–2012.

PARTICIPANTS/MATERIALS, SETTING, METHODS: Women in the GnRH antagonist protocol received daily injections with recombinant follicle-stimulating hormone, Puregon[®] and subcutaneous injections with GnRH antagonist, Orgalutran[®]. Women in the GnRH agonist protocol received nasal administration of the GnRH agonist, Synarela[®] and subcutaneous injections with FSH, Puregon[®]. The study design did not allow for a blinding procedure. All women self-reported the Profile of Mood States, the Perceived Stress Scale, the Symptom Checklist-92-Revised, and the Major Depression Inventory questionnaires, at baseline, at ART cycle day 35, on the day of oocyte pick-up, and on the day of hCG testing. Also, a series of Profile of Mood States were reported daily during pharmacological treatment to monitor mood fluctuations. The personality trait Neuroticism was assessed at baseline by the self-reported NEO-PI-R questionnaire.

MAIN RESULTS AND THE ROLE OF CHANCE: ART did not induce within- or between-protocol changes in any of the applied measures of mental distress. However, the GnRH antagonist protocol was associated with more pronounced median mood fluctuations during the stimulation phase (antagonist, 11.0 SD, [IQR = 21.1–6.1]; agonist, 8.9 SD, [IQR = 11.3–5.7], $P = 0.025$). This association became non-significant after applying a Bonferroni–Holm correction. Neuroticism was highly positively associated with increased levels of mental distress throughout treatment independent of protocols (all P -values < 0.006), and cross-sectional analysis revealed that women with high or low Neuroticism scores at baseline showed a significant trend towards lower chances of a positive pregnancy test (P -value = 0.028).

LIMITATIONS, REASONS FOR CAUTION: Information on prognostic factors such as preceding length of infertility, number of retrieved oocytes and number of prior insemination treatments was not accounted for in the analyses. The stratification of protocols by age in the subgroups of women included in this study was suboptimal. Women with prior or current use of antidepressant medication were excluded from our study.

WIDER IMPLICATIONS: Our results imply that mental distress emerging during ART treatment is not causally linked to hypogonadism *per se*

or to the choice of protocol. Rather, our data highlight the potential importance of (i) rapid increases in ovarian steroids and (ii) addressing personality traits indexing negative emotionality, i.e. Neuroticism, in women undergoing ART treatment, to optimize both emotional adjustment and, possibly, the chances of obtaining pregnancy.

STUDY FUNDING/COMPETING INTEREST(S): The Danish Research Council for Independent Research and MSD, Denmark kindly supported the study. The authors declare no competing financial interests.

TRIAL REGISTRATION NUMBER: EudraCT – 2008-005452-24.

Key words: mental distress / personality / assisted reproductive technology / ovarian stimulation protocol / neuroticism

Introduction

Women and men with fertility problems often experience their situation as highly stressful (Cousineau and Domar, 2007). The strain of undergoing assisted reproductive technologies (ART) is also well-documented (Hammarberg et al., 2001; Verhaak et al., 2007), reflected by the fact that psychological burden is a major reason for discontinuing treatment (Olivius et al., 2004; Gameiro et al., 2012). Such adverse psychological effects of ART treatment could have a negative impact on both mother and infant future health (O'hara and Swain, 1996; Eugster and Vingerhoets, 1999; Brouwers et al., 2001; Hjelmstedt et al., 2003; Alder et al., 2007), and currently it is not clear if mental distress experienced by women undergoing ART treatment is associated with chances of obtaining pregnancy (Boivin et al., 2011; Matthiesen et al., 2011). ART treatment may increase mental distress in women through a complex set of biological and psychological factors; controlled ovarian stimulation in ART is achieved by the pharmacological induction of sex steroid hormone changes, which could influence levels of mental distress as sex steroid hormones may play a role in the regulation of mood and the pathophysiology of mood disorders (Payne, 2003; Douma et al., 2005; Freeman et al., 2006, 2014; Munk-Olsen et al., 2006; Deecher et al., 2008). Especially, the administration of gonadotrophin-releasing hormone (GnRH) agonists has been coupled to negative mood symptoms, typically attributed to medically induced hypogonadism (Warnock et al., 1998; Patten and Barbui, 2004). Interestingly, adverse responses to changes in sex hormone levels appear only to affect a subgroup of women undergoing ART treatment (Van den Broeck et al., 2010; Bloch et al., 2011). Therefore identifying individual markers of susceptibility is pivotal to enable targeted prevention. The psychological construct of Neuroticism indexes individual differences in the tendency to experience negative emotions, impulsiveness, anxiety and angry hostility, and vulnerability to stress (McCrae and Costa, 2003). High Neuroticism scores have been associated with risk for major depression (Kendler and Myers, 2010), also in the context of stress (Jacobs et al., 2006), psychopathology in general (Ormel et al., 2013), and increased release of the stress hormone cortisol (Portella et al., 2005; Nater et al., 2010). However, the role of Neuroticism for ART-induced mental distress is at present unknown. In this study, we tested the following hypotheses: (i) women in the GnRH agonist protocol exhibit increased levels of mental distress compared with women in the GnRH antagonist protocol; (ii) mood fluctuations are more pronounced in the GnRH agonist protocol compared with the GnRH antagonist protocol; and (iii) neuroticism interacts with the protocols and independently affects levels of mental distress and mood fluctuations.

Method

Participants

A total of 83 eligible women (mean age: 33.1 ± 4.8 , range: 22–39 years) undergoing their first ART cycle were consecutively randomized 1:1 to a GnRH antagonist ($n = 42$) or GnRH agonist ($n = 41$) protocol by a project nurse, stratified by age (≤ 36 years and > 36 years) and the need for ICSI or general IVF. The study population was a subgroup of a larger ongoing Danish clinical randomized trial evaluating treatment outcome of the two protocols and was established as an add-on to the overall study in the period 2010–2012. Exclusion criteria were: prior IVF treatment, uterine anomalies, testicular sperm aspiration (TESA) needed, allergy to the ingredients used in the pharmacological treatment, reduced kidney or liver function, women > 40 years of age, or prior or current use of antidepressant medication. The study was registered as a clinical trial (EudraCT – 2008-005452-24) and approved by the Ethics Committee for the Capital Region of Denmark (H-B-2008-109). All participants signed an informed consent form.

Intervention

Women in the GnRH antagonist protocol received daily injections with the recombinant follicle-stimulating hormone (rFSH) analogue, Puregon[®], to initiate ovarian stimulation (150, i.e. ≤ 36 years, and 225, i.e. > 36 years, respectively) starting at cycle day 2–3. After 5 days of stimulation treatment, the women received additional daily subcutaneous injections with the GnRH antagonist, Orgalutran[®] (1×0.25 mg). Women in the GnRH agonist protocol received daily nasal administration of the GnRH agonist, Syranela[®], to suppress ovarian hormone production ($200 \text{ mg} \times 3$ daily) starting at cycle day 21. After 14 days of GnRH agonist administration (cycle day 35), the women received additional daily injections with Puregon[®] (150, i.e. ≤ 36 years and 225, i.e. > 36 years, respectively). Nasal administration of Syranela[®] was continued ($200 \text{ mg} \times 2$ daily) until the day of oocyte pick-up. In both protocols, ovulation induction was induced by subcutaneous injection with Ovitrelle[®] (6500, i.e.), when the three largest ovarian follicles had a diameter ≥ 17 mm. Oocyte retrieval was performed 36–38 h later.

Measures

Time points for data collection

Figure 1 is an overview of the study design. Participating women completed their questionnaires using a secure online survey system (<https://survey.nru.dk/>). Baseline questionnaires (T_0) were completed at home on the day of inclusion and randomization. A computer was set up at the fertility clinic, which the women accessed to complete their questionnaires when routinely attending the clinic for treatment at three time points: when ovarian stimulation was initiated (T_1) [at cycle day 35 for women in the agonist protocol]; on the day of oocyte pick-up (T_2); and on the day of hCG-testing (T_3). In addition, mood was reported daily during the pharmacological treatment from

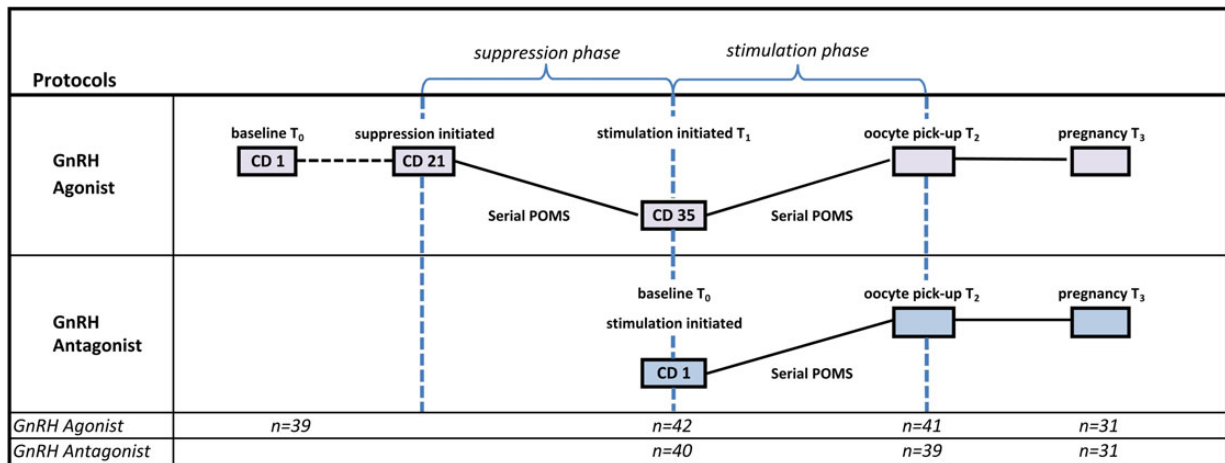

Figure 1 Overview of the treatment course, cycle days and time points of assessment in the two protocols. POMS: Profile of Mood States; Serial POMS: Series of daily reported mood disturbances scores (POMS) during pharmacological treatment; CD: cycle day.

home. At T₂, questionnaires were completed before the aspiration of follicles, and likewise, questionnaires were completed prior to hCG-testing at T₃. Baseline plasma measures of FSH, luteinizing hormone (LH) and plasma for determining estradiol concentrations were collected on the day of inclusion (T₀). Subsequent plasma samples were collected on the days described above as attendance points for questionnaires (T₁, T₂ and T₃).

The NEO Personality Inventory

At baseline (T₀), all women completed the Danish version (Skovdahl Hansen *et al.*, 2003) of the NEO Personality Inventory (NEO PI-R) (Costa and McCrae, 1992). The NEO PI-R is a self-report inventory, which measures five major domains of personality with six sub-facets for each domain. To serve the purpose of this study, the Neuroticism domain was used. The Neuroticism domain comprises 48 items (e.g. 'I am not a worrier' or 'I often get angry at the way people treat me') rated on a 5-point Likert scale from 0 (strongly disagree) to 4 (strongly agree). Individuals who score high on Neuroticism tend to experience difficulties in coping with stress and interpret the world around them as threatening and frustrating, which make them more prone to experience anxiety, anger, guilt, stress or sadness. In the present sample, internal consistency (Cronbach's alpha, α) for the Neuroticism domain was high, $\alpha = 0.91$.

The Profile of Mood States

The Profile of Mood States (POMS) is a psychological rating scale used to assess transient, distinct mood states (McNair *et al.*, 1992). It consists of six factors and a total score of mood disturbance rated by 65 adjectives (e.g. 'Furious', 'Hopeless' and 'Carefree') on a 5-point Likert scale from 1 (not at all) to 5 (extremely) based on the recollection of 'the last 24 h' for serial daily reports at home and 'past week including present day' for attendance at the clinic, respectively. For the purpose of this study, only the total mood disturbance scores were used. The POMS was completed at T₀, T₁, T₂ and T₃ and daily during the intervention. Internal consistency for the total mood disturbance score was high, $\alpha = 0.85$.

The Perceived Stress Scale

The Perceived Stress Scale (PSS) is a rating scale, which provides an overall estimation of the degree to which respondents experience their lives as unpredictable, uncontrollable and overloaded (Cohen *et al.*, 1983). It consists of 10 stress-related items (e.g. 'How often have you felt that you were unable to

control the important things in your life?') rated on a 5-point Likert scale from 0 (never) to 4 (very often) based on the recollection of the last 2 weeks. The PSS was completed at T₀, T₁, T₂ and T₃. Internal consistency for the PSS was high, $\alpha = 0.91$.

The Symptom Checklist Revised

The Danish version of the Symptom Checklist-90-Revised (SCL-92-R) (Olsen *et al.*, 2006) was used to assess severity of mental distress. The SCL-92-R comprises 92 items (e.g. 'difficulty making decision' or 'feeling afraid to go out of your house alone') rated on a 5-point Likert scale of distress from 0 (none) to 4 (extreme). Nine primary symptom scales and three global indices of distress are derived. For the purpose of this study, only the Global Severity Index (GSI) was used. The SCL-92-R was completed at T₀, T₁, T₂ and T₃. Internal consistency for the GSI was high, $\alpha = 0.95$.

The Major Depression Inventory

The Major Depression Inventory (MDI) is a rating scale of depressive symptoms according to DSM-IV and ICD-10 diagnostic criteria (Bech *et al.*, 2001). It comprises 10 items (e.g. 'Have you felt very restless?' or 'Have you suffered from reduced appetite?') rated on a 6-point Likert scale from 0 (never) to 5 (all the time) based on the recollection of the last 2 weeks. The MDI was completed at T₀, T₁, T₂ and T₃. Internal consistency for the MDI was high, $\alpha = 0.88$.

Reported measures

We use 'mental distress' as an umbrella term covering mood disturbances, perceived stress, global symptom distress and depressive symptoms, except when otherwise explicitly stated. Mood fluctuations are not included in this term and refer to the standard deviation (SD) of the serial reported mood disturbances scores for each woman during pharmacological treatment (see also under statistical analyses).

Plasma estradiol

Venous blood was drawn from all women at T₀, T₁, T₂ and T₃. Plasma was kept at a temperature between 2 and 8°C until analysed on a routine basis at the hospital laboratory after a maximum of 7 days. Estradiol concentrations were determined by electrochemiluminescence immunoassays (ECLIA) on a Cobas E601 Immunology Analyzer (Roche, Mannheim, Germany) with a lower detection limit of 0.02 nmol/l.

Statistical analyses

Main analyses

Demographic data were analysed using Student's *t*-tests or Mann–Whitney's *U*-tests for continuous data and Chi-square tests (χ^2) for categorical data. Friedman's test was used to examine ART-induced changes in mental distress and plasma estradiol within the protocols and Kruskal–Wallis one-way analysis of variance of the pair wise change (from $T_0 - T_2$) was used to examine differences in ART-induced changes in mental distress between the protocols. For interaction analyses, we used a general linear model adjusted for baseline measures of mental distress, age and BMI. Likewise, we used a general linear model for our cross-sectional analyses of Neuroticism effects on mental distress adjusted for age and BMI. Mann–Whitney's *U*-test was used to compare protocol differences in mood fluctuations. Levels of mood disturbances over the course of treatment fluctuated around a quite stationary mean in both protocols. This was evaluated using generalized estimating equations with independence working correlation structure showing no significant linear trends (all *P*-values > 0.22). We therefore assigned the SD around each woman's own mean as an index of fluctuations in serial daily reported mood disturbances scores (POMS) for the phases shown in Fig. 1. We controlled for the family-wise error-rate using the Bonferroni–Holm procedure (Holm, 1979). All presented *P*-values in the manuscript and the tables are uncorrected *P*-values.

Follow-up analysis

We conducted a follow-up cross-sectional analysis to examine whether baseline Neuroticism predicted probability of positive pregnancy test (as defined by hCG > 50 ui/l). This was analysed using logistic regression allowing a non-linear function of Neuroticism and measures of mental distress modelled flexibly using a natural cubic spline with a single knot at the median of the predictor adjusted for age, protocol and BMI (Harrell, 2001). All analyses were performed in SPSS (version 20.0) and R (version 3.0.1) (Team, 2013). We used a significance level of ≤ 0.05 and all hypothesis-tests were considered two-sided.

Results

Baseline data

Descriptive data for women in the GnRH antagonist and GnRH agonist protocols are shown in Table I. Median age differed significantly between the two protocols (antagonist, 31.2 years [IQR = 35.5–28.4]; agonist, 36.4 years [IQR = 37.6–32.7], $P = 0.001$). No women presented with clinical levels of psychopathology at baseline, according to established Danish criteria for clinical cut off scores on the SCL-92-R (Olsen, Mortensen and Bech, 2006), and no significant protocol differences were observed on measures of mental distress (Table I). Plasma concentrations of estradiol were not associated with measures of mental distress or Neuroticism at baseline (all *P*-values > 0.251); however, Neuroticism scores were, as expected, positively associated with mental distress at baseline (all *P*-values < 0.001, two-tailed).

Changes in mental distress

Contrary to our hypotheses, we observed no significant ART-induced, within protocol changes in mental distress from baseline (T_0) to the day of oocyte pick-up (T_2), including the suppression phase for women in GnRH agonist protocol (T_1) (Table II). Furthermore, we observed no differences in changes of mental distress from baseline (T_0) to the day of oocyte pick-up (T_2) between the agonist and antagonist protocols (all *P*-values > 0.125). We conducted a *post hoc* Friedman's test, which

Table I Descriptive baseline data.

Descriptive variables	Antagonist	Agonist	P-value
Age in years	31.2 [35.5–28.4]	36.4 [37.6–32.7]	0.001
Body mass index (kg/m ²)	24.9 ± 4.7	25.0 ± 5.6	0.817
Smoking (cigarettes per day)	0.5	0.6	0.705
Alcohol use (units per week)	1	1.2	0.433
Neuroticism scores	86.9 ± 22.0	84.7 ± 21.1	0.506
Mental distress			
POMS	8.0 [44.0–0.5]	8.0 [21.00–5.00]	0.197
PSS	13.5 [20.3–7.0]	12.0 [17.00–5.00]	0.298
MDI	6.0 [16.3–3.8]	6.0 [9.00–4.00]	0.407
SCL-92-R	0.3 [0.6–0.2]	0.3 [0.5–0.2]	0.529

Information obtained at baseline with medians and interquartile ranges in square brackets or means ± standard deviations and *P*-values of protocol differences. POMS, Profile of Mood States; PSS, Perceived Stress Scale; MDI, Major Depression Inventory; SCL-92-R, Symptom Checklist 92-Revised.

further included the day of hCG-testing (T_3) for the subgroup of women who had embryos transferred (Fig. 1). Here, a significant effect was observed for women in the GnRH antagonist protocol (Table II). Analyses of pair wise change (Kruskal–Wallis) showed a decrease in median perceived stress (PSS) from the day of oocyte pick-up (T_2) to the day of hCG-testing (T_3) for these women (T_2 , 13.0 PSS [IQR = 18.0–7.0]; T_3 , 10.0 PSS [IQR = 16.0–5.8], $P = 0.036$). Changes in estradiol during pharmacological treatment were assessed by calculating a change score (Δ) for each woman ($T_3 - T_0$ for all women and $T_1 - T_0$ for women in the agonist protocol only) (Δ antagonist, 3.30 ± 2.57 nmol/l; Δ agonist, 3.74 ± 2.57 and -0.11 ± 0.09 nmol/l, respectively). Neither the absolute concentrations of estradiol nor the magnitude of changes during pharmacological treatment were associated with levels of mental distress (all *P*-values > 0.203).

Mood fluctuations

To allow comparison between the phases in the treatment period, the GnRH agonist protocol was divided into a suppression and stimulation phase. During the stimulation phase, women in the GnRH antagonist protocol exhibited significantly more pronounced median mood fluctuation scores (SD's) relative to women in the GnRH agonist protocol (antagonist, 11.0 SD, [IQR = 21.1–6.1]; agonist, 8.9 SD, [IQR = 11.3–5.7], $P = 0.025$), which reflects a difference between protocols of ~20%. No difference was observed between the stimulation phase in GnRH antagonist protocol and the suppression phase in GnRH agonist protocol (Table III). Applying a Bonferroni–Holm correction rendered the observed difference in mood fluctuations non-significant.

Table II Mental distress and estradiol during ART treatment.

Mental distress	From baseline to the end of hormone stimulation						Including day of hCG-testing		
	Protocol	Baseline T ₀	Hypogonadal T ₁	Oocyte pick-up T ₂	X ²	P-value	hCG-test T ₃	X ²	P-value
POMS	Antagonist	8.0 [44.0–0.5]	–	11.0 [33.5–1.5]	0.676	0.506	9.0 [54.0–1.0]	0.838	0.658
	Agonist	8.0 [21.0–5.0]	1.0 [14.8–8.0]	0.0 [15.0–8.0]	1.860	0.409	10.0 [23.0–5.0]	3.913	0.271
PSS	Antagonist	13.5 [20.3–7.0]	–	13.0 [18.0–8.0]	0.273	0.731	9.0 [16.0–6.0]	7.707	0.029
	Agonist	12.0 [17.0–5.0]	9.0 [15.0–6.3]	10.0 [12.0–6.0]	0.595	0.749	9.0 [15.0–6.0]	1.541	0.673
MDI	Antagonist	6.0 [16.3–3.8]	–	7.0 [13.5–4.0]	0.111	0.864	7.0 [14.0–3.0]	0.703	0.704
	Agonist	6.0 [9.0–4.0]	6.5 [11.8–3.0]	6.0 [11.0–4.0]	1.750	0.417	8.0 [11.0–5.0]	2.286	0.515
SCL-92-R	Antagonist	0.3 [0.6–0.2]	–	0.3 [0.6–0.2]	0.027	1.000	0.3 [0.7–0.2]	1.461	0.482
	Agonist	0.3 [0.5–0.2]	0.3 [0.5–0.1]	0.2 [0.4–0.1]	0.268	0.887	0.3 [0.4–0.2]	3.271	0.352
Estradiol (nmol/l)	Antagonist	0.14 [0.24–0.11]	–	3.40 [4.22–2.19]	36.100	<0.001	0.35 [2.50–0.12]	30.260	<0.001
	Agonist	0.12 [0.18–0.09]	0.04 [0.06–0.00]	3.12 [5.11–2.07]	63.510	<0.001	0.18 [4.21–0.12]	67.070	<0.001

Friedman's test of within protocol changes at the various time points with medians and interquartile ranges in square brackets (see also Fig. 1). POMS, Profile of Mood States; PSS, Perceived Stress Scale; MDI, Major Depression Inventory; SCL-92-R, Symptom Checklist 92-Revised.

Table III Mood fluctuations during pharmacological treatment.

Protocol and phase	Suppression phase		Stimulation phase		P-value
	Days	SD	Days	SD	
Antagonist (N = 39)	–	–	10	11.0 [21.1–6.1]	0.531
Agonist (N = 37)	14	10.3 [14.9–7.0]	12	8.9 [11.3–5.7]	
Antagonist Stim. versus Agonist Supp.					0.025
Antagonist Stim. versus Agonist Stim.					

Mean duration (days) and median standard deviations (SD) and interquartile ranges in square brackets of daily mood disturbances (POMS) during pharmacological treatment with P-values of protocol differences. POMS, Profile of Mood States; Stim, stimulation phase; Supp., suppression phase.

Neuroticism

Neuroticism significantly predicted mental distress throughout treatment (all *P*-values < 0.006), but did not interact with protocols (all *P*-values > 0.115). Higher Neuroticism scores at baseline were also significantly associated with more pronounced mood fluctuations during

the stimulation phases across protocols (*P* = 0.035). In the cross-sectional follow-up analysis, a non-linear inverted U-shaped association was found, such that women with high or low Neuroticism scores at baseline showed a significant trend (*P*-value = 0.028) towards a lower probability of pregnancy (defined as hCG > 50 ui/l) (Fig. 2).

Discussion

We observed no significant changes in mental distress from baseline to the end of hormone stimulation, or a protocol × Neuroticism interaction, within or between the GnRH agonist and antagonist protocols. However, mood fluctuations were more pronounced during the stimulation phase for women in the GnRH antagonist protocol versus the GnRH agonist protocol. High Neuroticism scores were highly significantly associated with increased mental distress throughout treatment independent of protocols and with mood fluctuations during the stimulation phase. Also, a follow-up analysis suggested that women with high or low Neuroticism scores showed a significant trend towards a lower chance of pregnancy.

ART protocols and changes in mental distress

Contrary to our a priori hypothesis, the initial suppression phase in the GnRH agonist protocol was not associated with elevated symptoms of mental distress compared with baseline, suggesting that the initial suppression phase *per se* does not induce mental distress. Consistent with our findings, no exacerbations of mood symptoms during the hypogonadal phase were observed in women undergoing IVF treatment

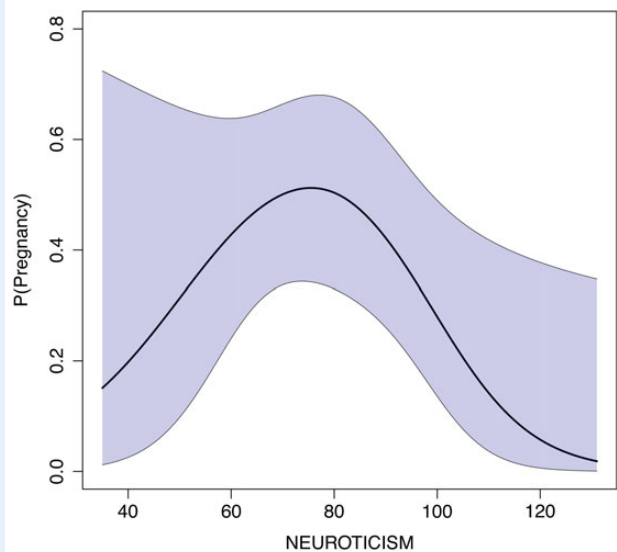

Figure 2 A non-linear association was observed, such that women with high or low Neuroticism scores at baseline showed a significant trend ($P = 0.028$) towards lower chances of pregnancy (defined as HCG > 50). This was examined using a logistic regression model with the effects of Neuroticism modelled using a natural cubic spline basis with a single knot located at the median. Although similar trends were observed using different statistical approaches, significance levels varied in both directions with the number and placement of knots, polynomial degree, and type of test (Wald/Likelihood Ratio Test). The grey area indicates the 95% confidence interval.

compared with baseline (Bloch et al., 2011). However, these findings contrast with an earlier study, where elevated symptoms of depression were observed during the hypogonadal phase in women undergoing their first cycle of conventional IVF treatment when compared with a mild ovarian stimulation with single embryo transfer protocol (de Klerk et al., 2006), and a smaller study, where symptoms of depression and anxiety progressively increased from baseline to the day of oocyte pick-up (Toren et al., 1996). The discrepant findings may to some extent reflect the use of different psychometric tools across studies. De Klerk et al. (2006) found elevated depressive symptoms during pituitary down-regulation using the self-reported Hospital Anxiety and Depression Scale (HADS) in women undergoing ART, unlike the present study and the study by Bloch et al. (2011), where no elevated levels of distress were found using SCL-92-R based measures. Toren et al. (1996) used the interview-based Hamilton Rating Scale and found elevated depressive symptoms during pituitary down-regulation corroborating de Klerk et al.'s (2006) findings. The HADS assesses only non-physical symptoms of anxiety and depression, while the SCL-92-R assesses a broad range of psychopathological symptoms and associated levels of global distress, making the latter more suitable for a global characterization of mental distress and the former more suitable for focusing on anxiety and depression in a medical population. Therefore it is possible that the SCL-92-R is less specific in detecting changes in mood and anxiety symptoms in women undergoing ART when compared with HADS. However, the women studied here presented with reproductive difficulties but were otherwise healthy and as de Klerk

et al. (2006) did not exclude women with prior or current use of anti-depressant medication, direct comparison between studies is difficult.

Mood fluctuations during ART treatment

Our data are consistent with the hypothesis that controlled ovarian hormone stimulation, in the absence of prior suppression of ovarian hormone production, is associated with more pronounced mood fluctuations. Rodent and non-human primate models suggest that both withdrawal from and exposure to ovarian hormones can potentially affect brain functions of relevance to emotional regulation and mood, such as serotonergic signalling (Bethea et al., 2002; Lu et al., 2003; Suda et al., 2008). However, it is far from clear how rapid hormone fluctuations may affect mental distress and through which mechanisms or which phases of fluctuations are the more critical (Ben Dor et al., 2013). Based on the current observations, we therefore speculate that prior treatment with GnRH agonists, at the time suppression is established, may dampen the potential adverse effects of subsequent controlled ovarian stimulation. However, correcting for multiple comparisons rendered the observation non-significant and replication is needed in order to validate this possible inter-protocol difference in mood fluctuations using a design with serial daily reports. The stimulation phase coincides with initiation of treatment in GnRH antagonist as opposed to GnRH agonist protocol. Therefore factors not induced pharmacologically (e.g. anxiety and expectation pressures related to the procedure) may also contribute to the observed differences in mood fluctuations.

The role of neuroticism

Neuroticism (i.e. negative emotions and stress vulnerability, impulsive and labile mood dispositions) was highly positively associated with increased levels of mental distress and with more pronounced mood fluctuations during the stimulation phase in both protocols. The latter suggests that higher levels of neuroticism combined with rapid increases in ovarian hormones may elicit adverse mood symptoms, such as unstable and labile mood. Corroborating this, similar personality constructs to Neuroticism have been coupled to subtle menstrual cycle disturbances (Demyttenaere et al., 1994), levels of ovarian reproductive hormones during the menstrual cycle (Ziomkiewicz et al., 2012), and infertility-related distress (Van den Broeck et al., 2010). High or low Neuroticism scores at baseline showed a significant trend towards subsequent negative pregnancy test. As Neuroticism is thought to be a risk marker for mental distress and depression, this is consistent with a meta-analysis on emotional distress and outcome of ART treatment in which perceived stress and trait/state anxiety showed a negative association with clinical pregnancy, and clinical depression showed a non-significant negative trend towards lower pregnancy rates (Matthiesen et al., 2011). Likewise, an adverse effect of Neuroticism and a positive effect of reducing stress on probability of pregnancy and live birth have been observed (Hämmerli et al., 2009; Volgsten et al., 2010). However, a recent meta-analysis did not report any association between pretreatment emotional distress and outcome of ART treatment (Boivin et al., 2011). The relatively few observations in the lower end of the Neuroticism spectrum in this study make interpretation of the association between low Neuroticism scores and chances of pregnancy somewhat inconclusive, as also reflected by the broad confidence interval (Fig. 2).

Of particular relevance for clinicians handling the treatment of subfertile women, personality appears to be a stronger predictor than choice of protocol for the mental distress experienced by women undergoing ART. If replicated, the ease of administration and the clinical relevance make ratings of Neuroticism an applicable tool for health care professionals in evaluating ART-related vulnerability to mental distress. Our tentative results also warrant further longitudinal investigation of the effect of personality and mental distress for successful ART treatment outcome, ideally with clinical end-points, such as number of live children born, and infant health measures.

Methodological considerations

The strength of this study is that it is part of a controlled randomized and prospective study with an extensive set-up of well-validated and reliable psychometric instruments covering the entire treatment cycle, including daily reports during pharmacological treatment. The study also took into account general psychological characteristics associated with increased risk of mood disorders, namely the personality trait, Neuroticism. However, the present findings should be interpreted under the following potentially important methodological limitations. First, even though only women undergoing their first ART-cycle were included, information on prognostic factors such as preceding length of infertility and number of prior inseminations was not accounted for in the analyses. Second, the stratification of protocols by age (≤ 36 years and > 36 years) in this subgroup of women was not successful. Hence, women in the GnRH antagonist protocol were younger on average than those in the GnRH agonist protocol. Moreover, the different doses of Puregon[®] administered across protocols (150, i.e. ≤ 36 years and 225, i.e. > 36 years, respectively) may have biased our results. However, age, group and BMI were included as covariates in our cross-sectional analyses. Third, women with prior or current use of antidepressant medication were excluded from our study. This is likely to have biased our study population towards low-risk women with lower Neuroticism scores. We may therefore have underestimated the effects of the stimulation phase on mood fluctuations and the predictive value of Neuroticism for mental distress and probability of pregnancy.

In conclusion, ART treatment did not induce elevated levels of mental distress and no differences between agonist and antagonist protocols or interactions with Neuroticism were observed. However, in the absence of prior ovarian hormone suppression (i.e. GnRH antagonist protocol), more pronounced mood fluctuations during the stimulation phase were observed, which was rendered non-significant after correcting for multiple comparisons. Neuroticism predicted levels of mental distress and mood fluctuations during treatment independent of protocols and was associated with probability of achieving pregnancy.

Acknowledgements

The authors thank the participating women.

Authors' roles

D.S.S.: contributed to conception and design of the study and the acquisition of data; managed literature searches; organized and conducted the statistical analyses; wrote the first draft of the manuscript; contributed substantially to analyses and interpretation of the results; and revised

the manuscript critically for important intellectual content. M.T.: contributed to conception and design of the study and the acquisition of data; carried out medical examinations of the participants; was involved in the statistical analyses; contributed substantially to analyses and interpretation of the results; and revised the manuscript critically for important intellectual content. L.V.H.: contributed to conception and design of the study; was involved in the statistical analyses; contributed substantially to analyses and interpretation of the results; and revised the manuscript critically for important intellectual content. P.S.J.: contributed to conception and design of the study; contributed considerably to analyses and interpretation of the results; and revised the manuscript critically for important intellectual content. K.K.H.: contributed considerably to analyses and interpretation of the results; conducted all modelling of the applied non-linear models; and revised the manuscript critically for important intellectual content. T.B.: contributed to conception and design of the study; carried out medical examinations of the participants; contributed considerably to analyses and interpretation of the results; and revised the manuscript critically for important intellectual content. T.H.: recruited all participants; handled data collection; and revised the manuscript critically for important intellectual content. J.B.: carried out medical examinations of the participants; substantially contributed to analyses and interpretation of data; and revised the manuscript critically for important intellectual content. A.P.: carried out medical examinations of the participants; substantially contributed to analyses and interpretation of data; and revised the manuscript critically for important intellectual content. P.H.: carried out medical examinations of the participants; substantially contributed to analyses and interpretation of data; and revised the manuscript critically for important intellectual content. V.G.F.: conceptualized and designed the study in collaboration with co-authors; participated in acquisition of data; managed literature searches; organized and contributed to the statistical analyses; contributed substantially to analyses and interpretation of the results; participated in manuscript drafting; and revised the manuscript critically for important intellectual content.

Funding

The Danish Research Council for Independent Research, The Lundbeck Foundation, The Capital Region of Denmark, Foundation for Health Research, and MSD, Denmark kindly supported the study.

Conflict of interest

None declared.

References

- Alder J, Fink N, Bitzer J, Hösl I, Holzgreve W. Depression and anxiety during pregnancy: a risk factor for obstetric, fetal and neonatal outcome? A critical review of the literature. *J Matern Fetal Neonatal Med* 2007;**20**:189–209.
- Bech P, Rasmussen NA, Olsen LR, Noerholm V, Abildgaard W. The sensitivity and specificity of the Major Depression Inventory, using the Present State Examination as the index of diagnostic validity. *J Affect Disord* 2001;**66**:159–164.
- Ben Dor R, Harsh VL, Fortinsky P, Koziol DE, Rubinow DR, Schmidt PJ. Effects of pharmacologically induced hypogonadism on mood and behavior in healthy young women. *Am J Psychiatry* 2013;**170**:426–433.

- Bethea CL, Lu NZ, Gundlach C, Streicher JM. Diverse actions of ovarian steroids in the serotonin neural system. *Front Neuroendocrinol* 2002; **23**:41–100.
- Bloch M, Azem F, Aharonov I, Ben Avi I, Yagil Y, Schreiber S, Amit A, Weizman A. GnRH-agonist induced depressive and anxiety symptoms during *in vitro* fertilization-embryo transfer cycles. *Fertil Steril* 2011; **95**:307–309.
- Boivin J, Griffiths E, Venetis CA. Emotional distress in infertile women and failure of assisted reproductive technologies: meta-analysis of prospective psychosocial studies. *BMJ* 2011;342.
- Brouwers EPM, van Baar AL, Pop VJM. Maternal anxiety during pregnancy and subsequent infant development. *Infant Behav Dev* 2001; **24**:95–106.
- Cohen S, Kamarck T, Mermelstein R. A global measure of perceived stress. *J Health Soc Behav* 1983; **24**:385–396.
- Costa PT, McCrae RR. *Professional Manual for Revised NEO Personality Inventory*. Odessa, Florida: Psychological Assessment Resources, 1992.
- Cousineau TM, Domar AD. Psychological impact of infertility. *Best Pract Res Clin Obstet Gynaecol* 2007; **21**:293–308.
- Deecher D, Andree TH, Sloan D, Schechter LE. From menarche to menopause: exploring the underlying biology of depression in women experiencing hormonal changes. *Psychoneuroendocrinology* 2008; **33**:3–17.
- de Klerk C, Heijnen EM, Macklon NS, Duivenvoorden HJ, Fauser BC, Passchier J, Hunfeld JA. The psychological impact of mild ovarian stimulation combined with single embryo transfer compared with conventional IVF. *Hum Reprod* 2006; **21**:721–727.
- Demyttenaere K, Nijs P, Evers-Kiebooms G, Koninckx PR. Personality characteristics, psychoendocrinological stress and outcome of IVF depend upon the etiology of infertility. *Gynecol Endocrinol* 1994; **8**:233–240.
- Douma SL, Husband C, O'Donnell ME, Barwin BN, Woodend AK. Estrogen-related mood disorders: reproductive life cycle factors. *ANS Adv Nurs Sci* 2005; **28**:364–375.
- Eugster A, Vingerhoets AJJM. Psychological aspects of *in vitro* fertilization: a review. *Soc Sci Med* 1999; **48**:575–589.
- Freeman EW, Sammel MD, Lin H, Nelson DB. Associations of hormones and menopausal status with depressed mood in women with no history of depression. *Arch Gen Psychiatry* 2006; **63**:375–382.
- Freeman EW, Sammel MD, Boorman DW, Zhang R. Longitudinal pattern of depressive symptoms around natural menopause. *JAMA Psychiatry* 2014; **71**:36–43.
- Gameiro S, Boivin J, Peronace L, Verhaak CM. Why do patients discontinue fertility treatment? A systematic review of reasons and predictors of discontinuation in fertility treatment. *Hum Reprod Update* 2012; **18**:652–669.
- Hammarberg K, Astbury J, Baker H. Women's experience of IVF: a follow-up study. *Hum Reprod* 2001; **16**:374–383.
- Hämmerli K, Znoj H, Barth J. The efficacy of psychological interventions for infertile patients: a meta-analysis examining mental health and pregnancy rate. *Hum Reprod Update* 2009; **15**:279–295.
- Harrell FE Jr. *Regression Modeling Strategies: With Applications to Linear Models, Logistic Regression and Survival Analysis*. New York: Springer, 2001.
- Hjelmstedt A, Widström A-M, Wramsby H, Matthiesen A-S, Collins A. Personality factors and emotional responses to pregnancy among IVF couples in early pregnancy: a comparative study. *Acta Obstet Gynecol Scand* 2003; **82**:152–161.
- Holm S. A simple sequentially rejective multiple test procedure. *Scand J Stat* 1979; **6**:65–70.
- Jacobs N, Kenis G, Peeters F, Derom C, Vlietinck R, van Os J. Stress-related negative affectivity and genetically altered serotonin transporter function: evidence of synergism in shaping risk of depression. *Arch Gen Psychiatry* 2006; **63**:989–996.
- Kendler KS, Myers J. The genetic and environmental relationship between major depression and the five-factor model of personality. *Psychol Med* 2010; **40**:801–806.
- Lu NZ, Eshleman AJ, Janowsky A, Bethea CL. Ovarian steroid regulation of serotonin reuptake transporter (SERT) binding, distribution, and function in female macaques. *Mol Psychiatry* 2003; **8**:353–360.
- Matthiesen SMS, Frederiksen Y, Ingerslev HJ, Zachariae R. Stress, distress and outcome of assisted reproductive technology (ART): a meta-analysis. *Hum Reprod* 2011; **26**:2763–2776.
- McCrae RR, Costa PT. *Personality in Adulthood: A Five-Factor Theory Perspective*, 2nd edn. New York: Guilford Press, 2003.
- McNair DM, Lorr M, Droppleman L. *Manual for the Profile of Mood States*. San Diego, CA: EdITS/Educational and Industrial Testing Service, 1992.
- Munk-Olsen T, Laursen T, Pedersen C, Mors O, Mortensen P. New parents and mental disorders: a population-based register study. *JAMA* 2006; **296**:2582–2589.
- Nater UM, Hoppmann C, Klumb PL. Neuroticism and conscientiousness are associated with cortisol diurnal profiles in adults—role of positive and negative affect. *Psychoneuroendocrinology* 2010; **35**:1573–1577.
- O'hara MW, Swain AM. Rates and risk of postpartum depression—a meta-analysis. *Int Rev Psychiatry* 1996; **8**:37–54.
- Olivius C, Friden B, Borg G, Bergh C. Why do couples discontinue *in vitro* fertilization treatment? A cohort study. *Fertil Steril* 2004; **81**:258–261.
- Olsen LR, Mortensen EL, Bech P. Mental distress in the Danish general population. *Acta Psychiatr Scand* 2006; **113**:477–484.
- Ormel J, Jeronimus BF, Kotov R, Riese H, Bos EH, Hankin B, Rosmalen JG, Oldehinkel AJ. Neuroticism and common mental disorders: meaning and utility of a complex relationship. *Clin Psychol Rev* 2013; **33**:686–697.
- Patten SB, Barbui C. Drug-induced depression: a systematic review to inform clinical practice. *Psychother Psychosom* 2004; **73**:207–215.
- Payne JL. The role of estrogen in mood disorders in women. *Int Rev Psychiatry* 2003; **15**:280–290.
- Portella MJ, Harmer CJ, Flint J, Cowen P, Goodwin GM. Enhanced early morning salivary cortisol in neuroticism. *Am J Psychiatry* 2005; **162**:807–809.
- Skovdahl Hansen H, Mortensen EL, Schiøtz HK. *NEO PI-R. Manual – Clinical. Danish Version*. Copenhagen: Dansk Psykologisk Forlag, 2003.
- Suda S, Segi-Nishida E, Newton SS, Duman RS. A postpartum model in rat: behavioral and gene expression changes induced by ovarian steroid deprivation. *Biol Psychiatry* 2008; **64**:311–319.
- Team RC. *R: A Language and Environment for Statistical Computing*. Vienna, Austria: R Foundation for Statistical Computing, 2013.
- Toren P, Dor J, Mester R, Mozes T, Blumensohn R, Rehavi M, Weizman A. Depression in women treated with a gonadotropin-releasing hormone agonist. *Biol Psychiatry* 1996; **39**:378–382.
- Van den Broeck U, D'Hooghe T, Enzlin P, Demyttenaere K. Predictors of psychological distress in patients starting IVF treatment: infertility-specific versus general psychological characteristics. *Hum Reprod* 2010; **25**:1471–1480.
- Verhaak CM, Smeenk JM, Nahuis MJ, Kremer JA, Braat DD. Long-term psychological adjustment to IVF/ICSI treatment in women. *Hum Reprod* 2007; **22**:305–308.
- Volgsten H, Ekselius L, Poromaa IS, Svanberg AS. Personality traits associated with depressive and anxiety disorders in infertile women and men undergoing *in vitro* fertilization treatment. *Acta Obstet Gynecol Scand* 2010; **89**:27–34.
- Warnock JK, Bundren JC, Morris DW. Depressive symptoms associated with gonadotropin-releasing hormone agonists. *Depress Anxiety* 1998; **7**:171–177.
- Ziomkiewicz A, Wichary S, Bochenek D, Pawlowski B, Jasienska G. Temperament and ovarian reproductive hormones in women: evidence from a study during the entire menstrual cycle. *Horm Behav* 2012; **61**:535–540.

PAPER 2

Title: Cerebral serotonin 4 receptor binding inversely associated with affective memory

Running title: 5-HT₄R associated with affective memory

Authors: Stenbæk, DS¹, Fisher, PM¹, Andersen, E¹, Hjordt, LV¹, Holst, KK^{1, 2}, McMahon, B¹, Hasselbalch, SG^{1, 3}, Frokjaer, VG¹, Knudsen, GM¹

Affiliations:

¹Neurobiology Research Unit and Center for Integrated Molecular Brain Imaging, Copenhagen, the Neuroscience Centre, Rigshospitalet, Denmark

²Department of Biostatistics, University of Copenhagen, Denmark

³Danish Dementia Research Centre, Department of Neurology, the Neuroscience Centre, Rigshospitalet, University of Copenhagen, Denmark

Corresponding author:

Dea Siggaard Stenbæk, MSc

Neurobiology Research Unit and of Center for Integrated Molecular Brain Imaging,
Rigshospitalet, Section 6932, 9 Blegdamsvej, DK-2100 Copenhagen O

Ph: +45 20 83 4838, mail: dea@nru.dk, fax: +45 35 45 67 13

Abstract

Background: Stimulation of the central serotonin 4 receptor (5-HT₄R) has advantageous effects on memory consolidation in animal models and we previously reported an inverse relationship between cerebral 5-HT₄R binding and memory in healthy volunteers. In order to advance our understanding of the 5-HT system's influence on affective cognitive processing, of relevance for e.g. affective disorders, we here examine the association between cerebral 5-HT₄R binding and affective memory.

Methods: Twenty-four healthy volunteers were scanned with [¹¹C]SB207145 Positron Emission Tomography (PET), which images the 5-HT₄R, and tested with the Verbal Affective Memory Test-24 (VAMT-24). A two latent variable structural equation model was used to evaluate the association between 5-HT₄R binding and affective memory.

Results: A significant inverse association between 5-HT₄R binding and affective memory performance ($p = 3 \times 10^{-5}$) and a marginally significant difference between word categories (negative, positive, and neutral) in their association with 5-HT₄R binding were observed. Post hoc analyses revealed a more negative association between positive word recall and 5-HT₄R binding compared to negative word recall.

Conclusions: Our findings confirm the presence of a negative association between 5-HT₄R binding and memory performance and provide novel evidence linking 5-HT signaling and affective memory biases in humans.

Key words: Serotonin, 5-HT₄ receptor, affective memory, negative biases, positron emission tomography

Introduction

Memory is vital for normal functioning and memory problems are some of the most commonly reported symptoms in neurological and psychiatric disorders, such as major depression (Austin *et al.*, 2001; Porter *et al.*, 2003; Gallassi *et al.*, 2006). Major depression patients are memory impaired in general, but also present specifically with so-called mood congruent- or affective memory biases. These are proposed to contribute to the emotional imbalance seen in major depression, by favouring negative information over positive information at different levels of information processing (Dalgleish, 2004; Elliott *et al.*, 2011) and as such sustain or worsen the depressed state. Therefore, knowledge about the molecular mechanisms that support affective memory is important.

The serotonin (5-HT) system is known to be critically involved in memory processes (Buhot, 1997; Meneses, 1999; Meneses, 2013) and impairment of the 5-HT system is considered an important etiological factor in major depression (Buhot *et al.*, 2000; Krishnan and Nestler, 2008). The 5-HT system is also the main target for antidepressant treatment (Morilak and Frazer, 2004). Thus, it is plausible that underlying molecular mechanisms may link affective memory processes with risk architectures for affective brain disorders. This hypothesis is supported by outcomes of pharmacological and dietary manipulations of the 5-HT system; in healthy volunteers lowering of central 5-HT levels with acute tryptophan depletion has been consistently associated with decreased verbal memory consolidation (Mendelsohn *et al.*, 2009; Sambeth *et al.*, 2009), and decreased recall for positive and neutral words as compared to negative words (Klaassen *et al.*, 2002; Kilkens *et al.*, 2004). In contrast, administration of selective serotonin reuptake inhibitors, which putatively increase central 5-HT levels, is associated with enhanced positive affective memory processing (Merens *et al.*, 2007; Harmer, 2008).

Key features of the 5-HT system can be indexed using Positron Emission Tomography (PET), such as specific pre - or postsynaptic receptor distributions. 5-HT₄ receptors (5-HT₄R) are widely expressed in brain regions involved in affective processing and memory including the hippocampus, amygdala, and frontal cortex (Eglen *et al.*, 1995; Lucas, 2009). Experimental studies have shown advantageous effects of pharmacological stimulation of 5HT₄R on memory consolidation (Bockaert *et al.*, 2008; King *et al.*, 2008), perhaps through increased release of acetylcholine (Bockaert *et al.*, 2004), and accumulating evidence suggests that the 5HT₄R is a potential pharmacological target for fast-acting antidepressant treatment (Vidal *et al.*, 2014). A recent human in vivo imaging study from our research group provided the first evidence linking 5-HT₄R and episodic memory performance in humans. Cerebral 5-HT₄R binding was found to be inversely related to recall of non-affective words using the Rey Auditory Verbal Learning Task (RAVLT) in healthy volunteers (Haahr *et al.*, 2013). However, the association between 5-HT₄R binding and recall of affective words was not examined and ceiling effects on RAVLT performance motivated a follow-up study in a novel cohort.

Here we evaluated the association between 5-HT₄R binding and performance on the Danish Verbal Affective Memory Test-24 (VAMT-24) in a healthy population. In addition to probing the association between brain 5-HT signalling and affective memory, this allowed us to evaluate if our previous findings could be replicated within a novel cohort. Based on our previous findings, we hypothesized a negative association between 5HT₄R binding and total recall of words. We further expected to find 5-HT₄R related differences in recall of neutral, positive, and negative words.

Methods and Materials

Participants

Twenty-four healthy participants (3 women) were recruited through Internet and newspaper advertisement. Eligible participants were screened for current and previous psychiatric symptoms, relevant medical history, alcohol, tobacco, illegal drug use, and abnormal blood tests. They also underwent a neurological examination by a trained clinician. Exclusion criteria for this study were significant medical history, which included psychiatric disorders, head trauma, a family history of psychiatric disorders, drug and alcohol abuse, and current or previous use of psychoactive drugs. Age ranged from 20 – 45 years (age = 26.72 ± 6.37 , mean \pm SD) and Body Mass Index (BMI) ranged from 19 – 31 kg/m² (BMI = 23.57 ± 2.96 , mean \pm SD) (Table 1). Educational scores were rated on a 5-point Likert scale; 1 (no vocational degree), 2 (<2 years of vocational education), 3 (2—4 years of vocational secondary education), 4 (2—4 years of academic education including a prior high school degree) to 5 (>4 years of academic education including a prior high school degree). Educational scores ranged from 1 – 5 (education = 4.0 ± 1.3 , mean \pm SD). Genotype information was available for all participants and included BDNF val66met and 5-HTTLPR polymorphisms. Written informed consent was obtained and the study was registered and approved by the Copenhagen municipality (VEK (KF) 01-2006-20) and the Capital Region Ethics Committee (VEK H-1-2010-085). The included participants have previously been part of a publication relating BDNF val66met and 5-HTTLPR polymorphisms and 5-HT₄R binding (Fisher *et al.*, 2014).

Measures

Verbal Affective Memory Task-24 (VAMT-24)

The VAMT-24 is a newly validated 24-word Danish affective memory test for use in healthy volunteers, developed by our research group. It is a computerized test of approximately 25 minutes and includes three conditions: 1) *Learning and Immediate recall* (IMM), in which participants view 24 words on a computer screen (list A-24) and are instructed to recall as many as possible. This procedure is repeated a total of five times; 2) *Short-term recall* (STM), in which participants view an interference list of 24 words on the computer screen (I-24) and are instructed to recall list A-24; and 3) *Long-term recall* (LTM), in which participants are asked to do a surprise recall of list A-24 after a period of 30 minutes. Word lists display a fixed, counterbalanced order of words with respect to valence (1=positive, 2=negative, 3=neutral): 123/321/231/132/312/213/132/213. The first and second words are positive and negative respectively, while the last is neutral to decrease test-inherent affective biases due to primacy and recency effects. Words with similar first letters are separated by at least four other words. Each word trial displays a fixation cross (750ms) and a word (750ms) in black (font=Times, size=40) on a grey background. The screen is viewed from a distance of ≈ 60 cm.

The recall scores were highly correlated within each word category in our sample (all $r > 0.61$) and significantly loaded onto a single latent variable (all $p < 2.6 \times 10^{-4}$). Thus, we did not find evidence for a differential effect between immediate, short-term, and long-term recall scores, and hence, were not able to disentangle the cognitive processes of encoding, retrieval and consolidation. As such, we computed a composite memory score for each word category. The computed composite score for each word category (positive: Total_{Pos}, negative: Total_{Neg}, and neutral: Total_{Neu} words) was therefore defined as: $Total_{cat} = IMM_{cat} + STM_{cat} + LTM_{cat}$,

where IMM_{cat} , STM_{cat} and LTM_{cat} , are immediate, short-term and long-term VAMT scores respectively, each for a given category.

PET and Magnetic Resonance Imaging (MRI)

[^{11}C]SB207145 was synthesized as previously described (Haahr *et al.*, 2014; Madsen *et al.*, 2014). Immediately after an intravenous bolus injection of [^{11}C]SB207145, a 120 min dynamic 3D PET scan (6x5s, 10x15s, 4x30 s, 5x120s, 5x300s, and 8x600s) was initiated using a High Resolution Research Tomograph (HRRT) with an approximate in plane resolution of 1.5 mm (Olesen *et al.*, 2009). The scans were reconstructed using the iterative PSF reconstruction with attenuation map improvements (Hong *et al.*, 2007; Comtat *et al.*, 2008; Sureau *et al.*, 2008). MRI was conducted on a 3T Siemens Magnetom Trio scanner (Erlangen, Germany). High-resolution 3D T1-weighted (matrix 256 x 256; 1x1x1mm³ voxels) and 2D T2-weighted sequences were acquired and corrected for spatial distortions and non-uniformity. The T1-weighted brain MRIs were segmented into gray matter, white matter, and cerebrospinal fluid using SPM5 (Wellcome Department of Cognitive Neurology, London, UK) and each voxel was assigned to the tissue class with the highest probability and this segmentation was subsequently used for delineation of the region of interest. The T2 weighted images served for brain masking purposes.

Pvelab was used to automatically delineate regions from the participant's structural MRI scan and time-activity curves within each region were determined (Svarer *et al.*, 2005). The binding potential (BP) of [^{11}C]SB207145 was modeled with the simplified reference tissue model using PMOD (PMOD, Zurich, Switzerland) with cerebellum as a reference region (Marner *et al.*, 2009), defined as: $BP_{ND} = f_{ND} * B_{avail} * (1/K_D)$, where f_{ND} is the free fraction of ligand in the nondisplaceable tissue compartment, B_{avail} is the concentration of receptors

available for binding, and K_D is the dissociation constant (Innis *et al.*, 2007). In total, four regions were included in our model: frontal cortex, amygdala, hippocampus and anterior cingulate cortex as these regions are commonly associated with memory and affect regulation (Eglen *et al.*, 1995; Elliott *et al.*, 2002). The frontal cortex region was delineated as a volume-weighted sum of orbitofrontal cortex, medial inferior frontal gyrus and superior frontal gyrus.

Statistics

Statistical analyses were carried out in SPSS (v20.0) and R (v3.0.2) (Team, 2013). We examined the association between Total_{Pos}, Total_{Neg}, and Total_{Neu} recall scores and 5-HT₄R binding using a two latent variable structural equation model and the Lava package in R (Holst and Budtz-Jørgensen, 2012) was used to obtain maximum likelihood estimates. Our initial model included the shared correlation between regional binding in frontal cortex, amygdala, hippocampus, and anterior cingulate gyrus modeled as one latent variable (u) and the shared correlation between Total_{Pos}, Total_{Neg}, and Total_{Neu} recall scores modeled as the second latent variable (m). We modeled the correlation between these two latent variables, reflecting the association between 5-HT₄R binding and memory performance, with an identifiable model using frontal cortex binding and positive word recall as reference scales.

Age was included as a predictor of both latent variables given compelling evidence supporting age effects on 5-HT₄R binding and memory performance (Grady and Craik, 2000; Madsen *et al.*, 2011). BMI, education, and genotype were not significant covariates and therefore not included in the final model. Sex was excluded as a predictor because there were so few women in the sample. Additional model paths were considered based on Score tests with a false-discovery rate (FDR) of $q < 0.05$ (Benjamini-Hochberg FDR corrected), which specify whether an additional path would significantly benefit the overall model fit (Figure 1).

Post hoc evaluation showed that weight adjusted injected mass did not significantly predict the 5-HT₄R latent variable ($p>0.6$) and was excluded from the final model. To test for differences across word categories in the association with 5-HT₄R binding, a Wald test was used.

Results

Descriptive data

Descriptive data are shown in Table 1. A large proportion of the sample was male (87.5%) and on average the participants were young, with a mean age of 26.7 years. An average of 7 days (range: 0 – 21 days) elapsed between VAMT-24 assessment and PET scan for 20 of the participants. The 4 remaining participants were tested within 7 months after the PET scans were acquired (average = 177 days, range: 163 – 211 days). The descriptive performance across word categories showed that neutral words ($Total_{Neu}$) were recalled more frequently compared to affective words ($Total_{Pos}$, $p < 0.0001$ and $Total_{Neg}$, $p = 0.001$), which were recalled with equal frequency ($p = 0.66$).

5-HT₄R binding and memory

The data supported our latent variable model structure, as indicated by a high correlation in 5-HT₄R binding across the delineated regions (LV_u : all factor loadings, $p < 0.0015$) and a high correlation in memory performance across affective valences (LV_m : all factor loadings, $p < 4.4 \times 10^{-6}$). Score tests supported an additional partial correlation between amygdala and hippocampus ($q = 0.004$). Following this specification, no additional paths were supported ($q > 0.94$) and we observed good model fit compared to a saturated model ($\chi^2 = 14.4$, $df = 17$, $p = 0.64$). The final model is shown in Figure 1.

Within our final model, 5-HT₄ receptor binding (LV_u) was significantly negatively associated with memory performance (LV_m), as reflected by the delineated path between the two respective latent variables (Estimate, -57.2 [-84.1 - -30.3], $p = 3.1 \times 10^{-5}$). Age was significantly negatively associated with memory performance (LV_m) (Estimate, -0.69 [-1.01 - -

0.37], $p = 2.5 \times 10^{-5}$), but not 5-HT₄R binding (LV_u) (Estimate, -0.0027 [-0.0065 - 0.0011], $p = 0.17$).

Differences across word categories and 5-HT₄R binding

A multivariate regression model with an unstructured correlation matrix was used to describe the association between age and frontal cortex 5-HT₄R binding and the three-dimensional response variable of affective memory performance (i.e., Total_{Pos}, Total_{Neg}, and Total_{Neu} recall scores). The overall difference in the association between word categories and 5-HT₄R binding was borderline significant (Wald test, $X^2 = 5.51$, $df = 2$, $p = 0.064$). Post hoc analyses of the individual contrasts between word categories and 5-HT₄R binding, in frontal cortex as the reference region, showed a more negative association between Total_{Pos} and 5-HT₄R binding compared to Total_{Neg} scores (Estimate, -26.9, [-49.5 - -4.3]), but not between Total_{Neu} - and Total_{Neg} scores (Estimate, -18.9, [-47.4 - 9.6]) or Total_{Pos} and - Total_{Neu} scores (Estimate, -7.9, [-30.1 - 14.2]) (Figure 2).

Discussion

In the present study we investigated the association between 5-HT₄R binding and affective memory in healthy volunteers. Using a two latent variable structural equation model, we found a significant inverse relationship between memory performance and 5-HT₄R binding. We also found a borderline significant overall difference between word categories in their association with 5-HT₄R binding and post hoc analyses revealed that the largest difference was between positive and negative word recall, with a steeper negative slope for the association between positive word recall and 5-HT₄R binding as compared to the one for negative word recall. Our findings confirm the presence of a negative association between 5-HT₄R binding and memory performance and provide novel evidence linking 5-HT signaling and affective memory biases in healthy humans.

5-HT₄R binding and affective memory performance

In our latent variable model, we showed that in vivo 5-HT₄R binding in fronto-limbic brain regions highly correlated with memory performance (Figure 1), which is consistent with the proposed molecular link between 5-HT and memory. We observed a highly significant intercorrelation in regional 5-HT₄R binding across the included brain regions, which suggests that 5-HT₄R effects on memory for the included regions may be regulated in a global manner and across memory processes, i.e encoding, retrieval and consolidation. These findings reinforce a link between an endogenous feature of brain 5-HT signaling and memory performance; a critical and often lacking piece of evidence supporting observed brain-behavior relations.

Evidence from animal models also implies a potent role of this receptor in memory and learning (Bockaert *et al.*, 2008; Meneses, 2013), as well as attenuated responses to stress and

novelty (Compan *et al.*, 2004). These findings may be a direct effect of 5-HT₄R agonism or perhaps reflect a central 5-HT tonus derived effect. Systemic injections of 5-HT₄R agonists or partial agonists improve performance in a broad spectrum of memory tasks (Marchetti *et al.*, 2000; Bockaert *et al.*, 2004), however, not always in a simple manner as 5-HT₄R agonists impaired memory in young rats but improved it in old rats (Lamirault and Simon, 2001). Thus, our results do not straight-forwardly reconcile with these animal models, where promnestic effects are generally found from 5-HT₄R agonism (Manuel-Apolinar *et al.*, 2005). We suggest that extrapolating from animal studies that have investigated direct effects of the 5-HT₄R agonism may not equate directly to the present findings, where the binding potential reflects a composite measure of both receptor density and affinity (Innis *et al.*, 2007).

There is ample evidence that 5-HT₄R availability is inversely related to cerebral 5-HT concentration. For example, three weeks of fluoxetine administration to healthy volunteers decreases 5-HT₄R binding (Haahr *et al.*, 2014), as is the case for rats exposed to three weeks of paroxetine administration (Licht *et al.*, 2009a). From a central 5-HT tonus perspective, the observed inverse relationship between 5-HT₄R binding and memory is, thus, consistent with the notion of high central 5-HT tonus (i.e., lower 5-HT₄R binding) being coupled to better memory performance (Meneses, 1999). Experimental stimulation of the 5-HT₄R may on the other hand reveal an important direct role of this receptor in specific memory processes, which remains to be clarified in humans. Further studies are needed to elucidate the functional significance of 5-HT₄R binding and affective memory; preferably in a prospective set-up with interventions either targeting 1) central 5-HT tonus to see whether changes in 5-HT₄R availability correlate with changes in affective memory biases to specify its functional role in healthy individuals or, for example, in responders versus non-responders to

antidepressant treatment or 2) direct pharmacological stimulation of the 5-HT₄R and affective memory correlates.

Importantly our findings replicate earlier findings from our research group of an inverse association between memory performance and 5-HT₄R binding in healthy volunteers (Haahr *et al.*, 2013) within a novel sample and using only high resolution PET scans. In the current study, immediate, short-term, and long-term recall scores were highly correlated within each word category and showed similar associations with 5-HT₄R binding, whereas a significant effect was only found for immediate recall scores in Haahr *et al.* (2013). The previously used memory paradigm, a 15-word verbal learning task (RAVLT), exhibited severe ceiling effects. Such ceiling effects were avoided here by using a 24-word Danish affective memory paradigm (VAMT-24) specifically developed for use in healthy samples. Thus, we propose that the results observed here provide a compelling validation of our previous findings using a memory test that is more sensitive to individual variability, and which also includes an affective component of memory.

5-HT₄ R binding and affective word categories; an affective bias?

Of particular interest to the study of affective memory biases, we tested whether word categories (positive, negative and neutral words) differed in their association with 5-HT₄R binding (Figure 2). The main effect of word category was only borderline significant, however, an exploratory evaluation of individual word categories showed that the largest difference was when positive words were contrasted to negative words. Thus, although our model indicated that 5-HT₄R binding was negatively associated with a single latent variable modeling word recall across word categories, this post hoc analysis suggests that relative recall of positive and negative words shifts towards a negative bias with increased 5-HT₄R

binding due to a steeper negative correlation for positive words (Figure 2). If these findings are interpreted in light of a central 5-HT tonus perspective, they are consistent with the proposition that low central 5-HT tonus (corresponding to a higher 5-HT₄R binding in Figure 2) underlies negative memory bias tendencies (Elliott *et al.*, 2011). In healthy individuals this 5-HT₄R associated negative memory bias may represent a risk marker of mood disorders, such as major depression, at an endophenotype level.

Whereas many previous studies have demonstrated that pharmacological manipulation of 5-HT signaling leads to changes in affective processing (Harmer *et al.*, 2002; Harmer *et al.*, 2004; Molodtsova, 2008; Mendelsohn *et al.*, 2009), this novel and intriguing observation links an endogenous feature of 5-HT signaling with affective memory biases in healthy individuals. Evidence is converging to support the hypothesis that antidepressants work through stimulating affective memory systems so as to counteract the negative biases shown by depressive patients (Harmer, 2008; Harmer *et al.*, 2009). Notably, the typical antidepressant response interval of 2-3 weeks, during which there may be a restructuring of affective orientation, is consistent with the time interval over which antidepressants were shown to affect central 5-HT₄R in animal models and humans (Licht *et al.*, 2009b; Marnier *et al.*, 2010; Haahr *et al.*, 2014). Thus, 5-HT₄R related effects could help explain the time course of antidepressants. Given the prevalence of depression and 5-HT-targeted drugs, as well as the significant side-effects associated with these drugs, uncovering more specific symptom-to-treatment relationships will be of value in future medicinal work.

Limitations

Although our findings provide evidence for an association between central 5-HT₄R binding and affective memory recall, some limitations should be considered. First, we had a relatively

small sample size and we may therefore have been underpowered to detect and disentangle memory-specific effects, i.e. encoding, consolidation, and retrieval. However, our findings do not appear driven by single data points and critically, the present study has a superior design and replicates a previously reported association between 5-HT₄R binding and memory performance in healthy volunteers (Haahr *et al.*, 2013). Second, we were not able to address the potential moderating role of sex for the investigated association between central 5-HT₄R binding and affective memory, due to the low number of women included. Given the higher prevalence of major depression in women and earlier reported sex differences in 5-HT₄R binding (Madsen *et al.*, 2011), this is relevant to consider in future studies. Finally, we were not able to address region-specific changes in 5-HT release in response to memory performance with the applied static PET-signal. Future studies integrating a pharmacological challenge of the 5-HT system with a PET radioligand sensitive to acute changes in brain 5-HT levels would help elucidate how such region-specific dynamics are related to affective memory performance.

Conclusion

In conclusion, we here present evidence of a significant inverse relation between cerebral 5-HT₄R binding and affective memory performance in healthy volunteers. We find for the first time evidence for a differential association depending on affective word category. These findings support the relevance of 5-HT₄R in relation to affective components of memory and provide insight into molecular mechanisms that may contribute to the risk architectures for affective disorders and antidepressants effects.

Acknowledgements

We would like to thank B. Dall, G. Thomsen, S. Larsen, A. Dyssegaard, and L. Freyr for their assistance with the data collection. We thank J. Frederking for her contribution to the figures. We would also like to acknowledge and thank The John and Birthe Meyer Foundation for the donation of the Cyclotron and PET scanner.

Author declarations

The authors declare no conflict of interest

Table 1: Descriptive data

Measures	N	Mean / Percentage	SD	Minimum	Maximum
Age in years	24	26,7	6,4	20	45
Body mass index (kg/m ²)	24	23,6	3	19	31
Gender (% male)	24	87,5			
Education	24	4.0	1,3	1	5
Total _{pos}	24	32,8	7,9	15	50
Total _{Neg}	24	33,3	7,9	17	47
Total _{Neu}	24	38,6	7,3	28	53

Note: Total_{pos}: total recall of positive words, Total_{neg}: total recall of negative words, Total_{neu}:

total recall of neutral words. A total of 56 words is the maximum recall for each word category.

Figure 1:

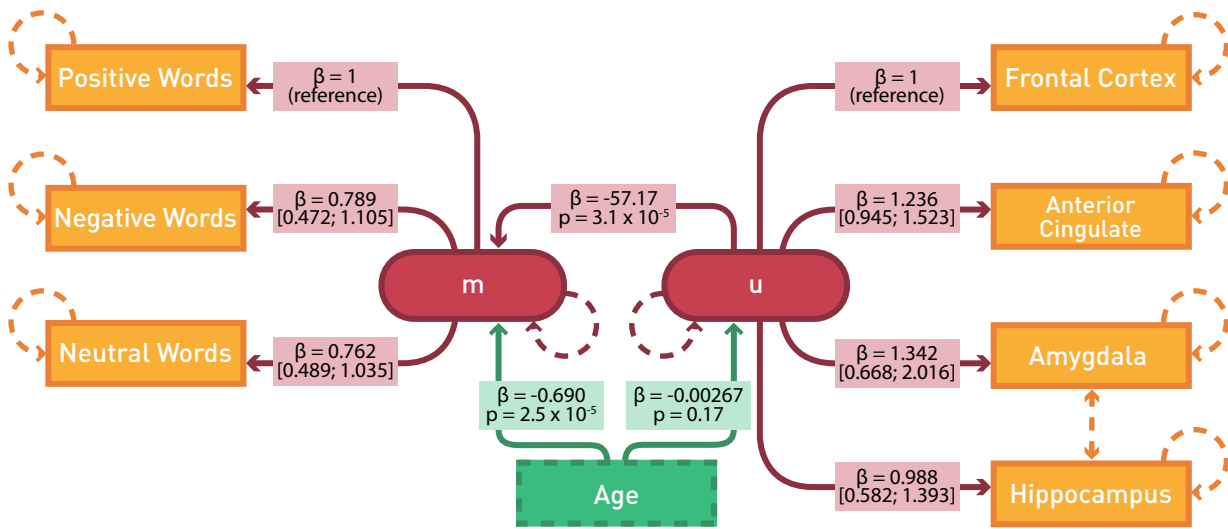

A schematic overview of the applied two latent variable structural equation model. The final model is depicted with model paths. The red circles represent the two latent variables (m = memory component and u = 5-HT₄R component). The orange boxes predicted by the latent variable u represent measured regional [¹¹C]SB207145 binding potential values and the orange boxes predicted by the latent variable m represent measured word categories total recall. The green box represents age as a predictor of the two latent variables. The hatched orange line between amygdala and hippocampus indicates additional shared correlation and the remaining hatched red and orange lines indicate they are estimated with error. Parameter estimates (β) are noted for each delineated path in pink and green boxes, which also include 95% confidence intervals for parameter estimates between each latent variables and predicted measures. P-values are given for the association between the two latent variables and for effects of age.

Figure 2:

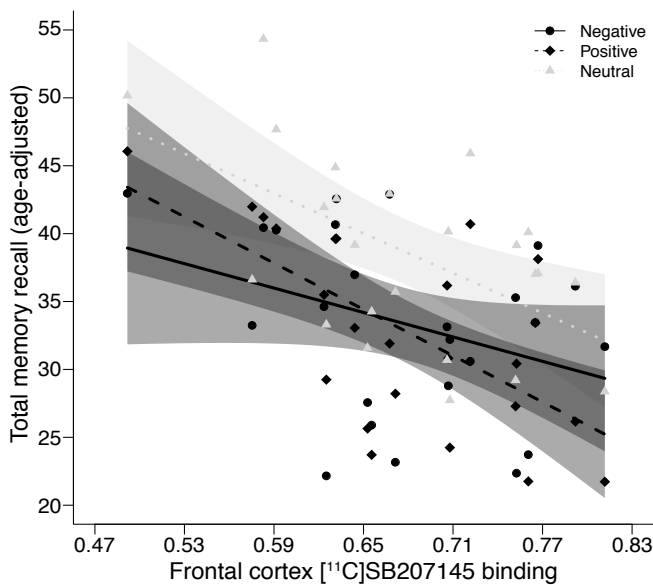

A grouped scatter plot of [^{11}C]SB207145 binding potential values plotted against total memory recall. Red, blue, and yellow dots represent negative, positive, and neutral word recall, respectively. Lines and shading for each line represent slope estimates and 95% confidence intervals respectively. The data shown are adjusted for age. Our data indicate an inverse relation between memory recall and [^{11}C]SB207145 binding. They also suggest a steeper slope for positive word recall as compared to negative and that the relative recall between positive and negative words changes with [^{11}C]SB207145 binding. More negative words relative to positive words are recalled with increasing binding and the opposite with decreasing binding.

References

- Austin, M.-P., Mitchell, P. & Goodwin, G. (2001) Cognitive deficits in depression: Possible implications for functional neuropathology. *The British Journal of Psychiatry*, **178**(3), pp. 200-206.
- Bockaert, J., Claeysen, S., Compan, V. & Dumuis, A. (2004) 5-HT₄ Receptors. *CNS & Neurological Disorders - Drug Targets (Formerly Current Drug Targets - CNS & Neurological Disorders)*, **3**(1), pp. 39-51.
- Bockaert, J., Claeysen, S., Compan, V. & Dumuis, A. (2008) 5-HT₄ receptors: History, molecular pharmacology and brain functions. *Neuropharmacology*, **55**(6), pp. 922-931.
- Buhot, M.-C. (1997) Serotonin receptors in cognitive behaviors. *Curr Opin Neurobiol*, **7**(2), pp. 243-254.
- Buhot, M.-C., Martin, S. & Segu, L. (2000) Role of serotonin in memory impairment. *Ann Med*, **32**(3), pp. 210-221.
- Compan, V., Zhou, M., Grailhe, R., Gazzara, R. A., Martin, R., Gingrich, J., Dumuis, A., Brunner, D., Bockaert, J. & Hen, R. (2004) Attenuated response to stress and novelty and hypersensitivity to seizures in 5-HT₄ receptor knock-out mice. *J Neurosci*, **24**(2), pp. 412-419.
- Comtat, C., Sureau, F. C., Sibomana, M., Hong, I. K., Sjolholm, N. & Trebossen, R. (2008) Image based resolution modeling for the HRRT OSEM reconstructions software. *Nuclear Science Symposium Conference Record, 2008. NSS '08. IEEE*.
- Dalgleish, T. (2004) The emotional brain. *Nat Rev Neurosci*, **5**(7), pp. 583-589.
- Eglen, R. M., Wong, E. H. F., Dumuis, A. & Bockaert, J. (1995) Central 5-HT₄ receptors. *Trends Pharmacol Sci*, **16**(11), pp. 391-398.
- Elliott, R., Rubinsztein, J. S., Sahakian, B. J. & Dolan, R. J. (2002) The neural basis of mood-congruent processing biases in depression. *Arch Gen Psychiatry*, **59**(7), pp. 597-604.
- Elliott, R., Zahn, R., Deakin, J. F. W. & Anderson, I. M. (2011) Affective Cognition and its Disruption in Mood Disorders. *Neuropsychopharmacology*, **36**(1), pp. 153-182.
- Fisher, P. M., Holst, K. K., Adamsen, D., Klein, A. B., Frokjaer, V. G., Jensen, P. S., Svarer, C., Gillings, N., Baare, W. F., Mikkelsen, J. D. & Knudsen, G. M. (2014) BDNF Val66met and 5-HTTLPR polymorphisms predict a human in vivo marker for brain serotonin levels. *Hum Brain Mapp*.
- Gallassi, R., Di Sarro, R., Morreale, A. & Amore, M. (2006) Memory impairment in patients with late-onset major depression: The effect of antidepressant therapy. *J Affect Disord*, **91**(2-3), pp. 243-250.
- Grady, C. L. & Craik, F. I. M. (2000) Changes in memory processing with age. *Curr Opin Neurobiol*, **10**(2), pp. 224-231.

- Harmer, C., Bhagwagar, Z., Cowen, P. & Goodwin, G. (2002) Acute administration of citalopram facilitates memory consolidation in healthy volunteers. *Psychopharmacology (Berl)*, **163**(1), pp. 106-110.
- Harmer, C. J. (2008) Serotonin and emotional processing: Does it help explain antidepressant drug action? *Neuropharmacology*, **55**(6), pp. 1023-1028.
- Harmer, C. J., O'Sullivan, U., Favaron, E., Massey-Chase, R., Ayres, R., Reinecke, A., Goodwin, G. M. & Cowen, P. J. (2009) Effect of acute antidepressant administration on negative affective bias in depressed patients. *Am J Psychiatry*, **166**(10), pp. 1178-1184.
- Harmer, C. J., Shelley, N. C., Cowen, P. J. & Goodwin, G. M. (2004) Increased positive versus negative affective perception and memory in healthy volunteers following selective serotonin and norepinephrine reuptake inhibition. *Am J Psychiatry*, **161**(7), pp. 1256-1263.
- Holst, K. & Budtz-Jørgensen, E. (2012) Linear latent variable models: the lava-package. *Computational Statistics*, pp. 1-68.
- Hong, I. K., Chung, S. T., Kim, H. K., Kim, Y. B., Son, Y. D. & Cho, Z. H. (2007) Ultra Fast Symmetry and SIMD-Based Projection-Backprojection (SSP) Algorithm for 3-D PET Image Reconstruction. *Medical Imaging, IEEE Transactions on*, **26**(6), pp. 789-803.
- Haahr, M. E., Fisher, P., Holst, K., Madsen, K., Jensen, C. G., Marnier, L., Lehel, S., Baaré, W., Knudsen, G. & Hasselbalch, S. (2013) The 5-HT₄ receptor levels in hippocampus correlates inversely with memory test performance in humans. *Hum Brain Mapp*, **34**(11), pp. 3066-3074.
- Haahr, M. E., Fisher, P. M., Jensen, C. G., Frokjaer, V. G., Mahon, B. M., Madsen, K., Baaré, W. F. C., Lehel, S., Norremolle, A., Rabiner, E. A. & Knudsen, G. M. (2014) Central 5-HT₄ receptor binding as biomarker of serotonergic tone in humans: a [¹¹C]SB207145 PET study. *Mol Psychiatry*, **19**(4), pp. 427-432.
- Innis, R. B., Cunningham, V. J., Delforge, J., Fujita, M., Gjedde, A., Gunn, R. N., Holden, J., Houle, S., Huang, S.-C., Ichise, M., Iida, H., Ito, H., Kimura, Y., Koeppe, R. A., Knudsen, G. M., Knuuti, J., Lammertsma, A. A., Laruelle, M., Logan, J., Maguire, R. P., Mintun, M. A., Morris, E. D., Parsey, R., Price, J. C., Slifstein, M., Sossi, V., Suhara, T., Votaw, J. R., Wong, D. F. & Carson, R. E. (2007) Consensus nomenclature for in vivo imaging of reversibly binding radioligands. *J Cereb Blood Flow Metab*, **27**(9), pp. 1533-1539.
- Kilkens, T. O., Honig, A., van Nieuwenhoven, M. A., Riedel, W. J. & Brummer, R. J. (2004) Acute tryptophan depletion affects brain-gut responses in irritable bowel syndrome patients and controls. *Gut*, **53**(12), pp. 1794-1800.
- King, M. V., Marsden, C. A. & Fone, K. C. F. (2008) A role for the 5-HT_{1A}, 5-HT₄ and 5-HT₆ receptors in learning and memory. *Trends Pharmacol Sci*, **29**(9), pp. 482-492.
- Klaassen, T., Riedel, W. J., Deutz, N. E. & Van Praag, H. M. (2002) Mood congruent memory bias induced by tryptophan depletion. *Psychol Med*, **32**(1), pp. 167-172.
- Krishnan, V. & Nestler, E. J. (2008) The molecular neurobiology of depression. *Nature*, **455**(7215), pp. 894-902.

Lamirault, L. & Simon, H. (2001) Enhancement of place and object recognition memory in young adult and old rats by RS 67333, a partial agonist of 5-HT₄ receptors. *Neuropharmacology*, **41**(7), pp. 844-853.

Licht, C. L., Marcussen, A. B., Wegener, G., Overstreet, D. H., Aznar, S. & Knudsen, G. M. (2009a) The brain 5-HT₄ receptor binding is down-regulated in the Flinders Sensitive Line depression model and in response to paroxetine administration. *J Neurochem*, **109**(5), pp. 1363-1374.

Licht, C. L., Marcussen, A. B., Wegener, G., Overstreet, D. H., Aznar, S. & Knudsen, G. M. (2009b) The brain 5-HT₄ receptor binding is down-regulated in the Flinders Sensitive Line depression model and in response to paroxetine administration. *J Neurochem*, **109**(5), pp. 1363-1374.

Lucas, G. (2009) Serotonin Receptors, Type 4: A New Hope? *Current Drug Targets*, **10**(11), pp. 1085-1095.

Madsen, K., Haahr, M. T., Marner, L., Keller, S. H., Baare, W. F., Svarer, C., Hasselbalch, S. G. & Knudsen, G. M. (2011) Age and sex effects on 5-HT₄ receptors in the human brain: a [¹¹C]SB207145 PET study. *J Cereb Blood Flow Metab*, **31**(6), pp. 1475-1481.

Madsen, K., Torstensen, E., Holst, K. K., Haahr, M. E., Knorr, U., Frokjaer, V. G., Brandt-Larsen, M., Iversen, P., Fisher, P. M. & Knudsen, G. M. (2014) *Familial risk for major depression is associated with lower striatal 5-HT₄ receptor binding.*

Manuel-Apolinar, L., Rocha, L., Pascoe, D., Castillo, E., Castillo, C. & Meneses, A. (2005) Modifications of 5-HT₄ receptor expression in rat brain during memory consolidation. *Brain Res*, **1042**(1), pp. 73-81.

Marchetti, E., Dumuis, A., Bockaert, J., Soumireu-Mourat, B. & Roman, F. S. (2000) Differential modulation of the 5-HT₄ receptor agonists and antagonist on rat learning and memory. *Neuropharmacology*, **39**(11), pp. 2017-2027.

Marner, L., Gillings, N., Comley, R. A., Baaré, W. F. C., Rabiner, E. A., Wilson, A. A., Houle, S., Hasselbalch, S. G., Svarer, C., Gunn, R. N., Laruelle, M. & Knudsen, G. M. (2009) Kinetic Modeling of ¹¹C-SB207145 Binding to 5-HT₄ Receptors in the Human Brain In Vivo. *Journal of Nuclear Medicine*, **50**(6), pp. 900-908.

Marner, L., Gillings, N., Madsen, K., Erritzoe, D., Baare, W. F., Svarer, C., Hasselbalch, S. G. & Knudsen, G. M. (2010) Brain imaging of serotonin 4 receptors in humans with [¹¹C]SB207145-PET. *Neuroimage*, **50**(3), pp. 855-861.

Mendelsohn, D., Riedel, W. J. & Sambeth, A. (2009) Effects of acute tryptophan depletion on memory, attention and executive functions: A systematic review. *Neuroscience & Biobehavioral Reviews*, **33**(6), pp. 926-952.

Meneses, A. (1999) 5-HT system and cognition. *Neuroscience & Biobehavioral Reviews*, **23**(8), pp. 1111-1125.

Meneses, A. (2013) 5-HT systems: emergent targets for memory formation and memory alterations. *Rev Neurosci*.

- Merens, W., Willem Van der Does, A. J. & Spinhoven, P. (2007) The effects of serotonin manipulations on emotional information processing and mood. *J Affect Disord*, **103**(1–3), pp. 43-62.
- Molodtsova, G. F. (2008) Serotonergic mechanisms of memory trace retrieval. *Behav Brain Res*, **195**(1), pp. 7-16.
- Morilak, D. A. & Frazer, A. (2004) Antidepressants and brain monoaminergic systems: a dimensional approach to understanding their behavioural effects in depression and anxiety disorders. *The International Journal of Neuropsychopharmacology*, **7**(02), pp. 193-218.
- Porter, R. J., Gallagher, P., Thompson, J. M. & Young, A. H. (2003) Neurocognitive impairment in drug-free patients with major depressive disorder. *The British Journal of Psychiatry*, **182**(3), pp. 214-220.
- Sambeth, A., Riedel, W., Tillie, D., Blokland, A., Postma, A. & Schmitt, J. (2009) Memory impairments in humans after acute tryptophan depletion using a novel gelatin-based protein drink. *Journal of Psychopharmacology*, **23**(1), pp. 56-64.
- Sureau, F. C., Reader, A. J., Comtat, C., Leroy, C., Ribeiro, M.-J., Buvat, I. & Trébossen, R. (2008) Impact of Image-Space Resolution Modeling for Studies with the High-Resolution Research Tomograph. *Journal of Nuclear Medicine*, **49**(6), pp. 1000-1008.
- Svarer, C., Madsen, K., Hasselbalch, S. G., Pinborg, L. H., Haugbøl, S., Frøkjær, V. G., Holm, S., Paulson, O. B. & Knudsen, G. M. (2005) MR-based automatic delineation of volumes of interest in human brain PET images using probability maps. *Neuroimage*, **24**(4), pp. 969-979.
- Team, R. C. (2013) *R: A language and environment for statistical computing*, Vienna, Austria, R Foundation for Statistical Computing.
- Vidal, R., Castro, E., Pilar-Cuéllar, F., Pascual-Brazo, J., Díaz, A., Rojo, M. L., Linge, R., Martín, A., Valdizán, E. M. & Pazos, A. (2014) Serotonin 5-HT₄ receptors: A new strategy for developing fast acting antidepressants? *Curr Pharm Des*, **20**(23), pp. 3751-3762.

PAPER 3

Title: Transient sex-steroid hormone manipulation slows reaction time and increases mood variability but does not affect verbal memory in young healthy women

Authors: Stenbæk, DS^{1,2}, Fisher, PM¹, Budtz-Jørgensen⁴, E, Pinborg A^{2,3}, Hjordt, LV^{1,2}, Jensen, PS¹, Knudsen, GM^{1,2}, Frokjaer, VG¹

Affiliations: ¹Neurobiology Research Unit and Center for Integrated Molecular Brain Imaging, Rigshospitalet, Copenhagen, Denmark

²Faculty of Health and Medical Sciences, University of Copenhagen University Hospital

³Fertility Department, Copenhagen University Hospital, Rigshospitalet, Denmark

⁴Department of Biostatistics, University of Copenhagen, Denmark

Keywords: Estradiol, Gonadotrophin-Releasing-Hormone agonist, serotonin, serotonin transporter, verbal affective memory, mood, simple reaction time, mental distress, major depression

Study funding: The Danish Research Council for Independent Research, The Capitol Region of Denmark, Foundation for Health Research, and The Lundbeck Foundation kindly supported the study.

Corresponding author: Vibe G. Frokjaer, MD, PhD, Neurobiology Research Unit 6931, Copenhagen University Hospital, Rigshospitalet, Blegdamsvej 9, DK-2100 Copenhagen, Denmark, Telephone: +45 35456712, Fax: +45 35456713. Email: vibe@nru.dk

ABSTRACT

Background: Women have a two time fold greater risk for depression compared to men and epidemiological evidence show increased risk of depressive symptoms in life phases where ovarian hormone levels fluctuate or decline rapidly, i. e., postpartum and during menopausal transition. The mechanisms behind this risk are largely unknown but may include changes in mental state and cognition, possibly mediated by changes in serotonergic neurotransmission.

Methods: In a randomized controlled double-blinded trial, 61 healthy women (mean age 24.3 \pm 4.9 years) were tested at baseline and at follow-up after receiving gonadotropin-releasing hormone agonist (GnRHa) or placebo intervention. We tested direct effects of intervention and effects mediated by changes in neocortical serotonin transporter (5-HTT) binding on verbal affective memory recall, simple reaction time and self-reported measures of mental distress including daily mood profiles.

Results: Compared to placebo, GnRHa intervention induced an increase in simple reaction time ($p=0.03$) and more pronounced fluctuations in daily reported mood in a manner dependent on baseline mood ($p=0.003$) and Neuroticism ($p=0.01$). Total verbal affective memory recall, affective recall bias, and overall self-perceived mental distress were not affected. Within the GnRHa group, a larger decline in serum estradiol from baseline was associated with higher levels of perceived stress. We could not confirm that neocortical 5-HTT binding mediated these effects.

Conclusions: In young healthy women with a natural menstrual cycle, transient sex-steroid hormone manipulation decreases speed of information processing and produces more labile mood in women with high levels of mood disturbances at baseline.

INTRODUCTION

The prevalence of depression is twice as high for women relative to men (Kessler *et al.*, 1993; Kessler *et al.*, 2005). Women are also more likely to experience greater symptom severity concurrent with higher rates of co-morbid disorders (Marcus *et al.*, 2008). Epidemiological evidence shows an increased risk for depression and mood disturbances in life phases, where ovarian hormones fluctuate or decline rapidly (Deecher *et al.*, 2008), such as postpartum (O'Hara, 1996; Gavin *et al.*, 2005; Le Strat *et al.*, 2011) and during menopausal transition (Freeman *et al.*, 2014). In the postpartum period, the incidence of Postpartum Depression (PPD) peaks at day 10 to 19 (Munk-Olsen *et al.*, 2006), and the strongest predictor of a depressive episode during the menopausal transition appears to be the magnitude by which estradiol levels fluctuate around a woman's own mean (Freeman *et al.*, 2006).

Ovarian hormones, i.e., mainly estrogens and progesterone, serve to structure and maintain the neuroendocrine milieu throughout female life (Chakraborti *et al.*, 2007; McEwen *et al.*, 2012). Neuroimaging studies of naturally cycling women and peri- and postmenopausal women have shown that ovarian steroids influence brain activation in regions that underpin emotional and cognitive processes (Comasco *et al.*, 2014; Toffoletto *et al.*, 2014). In particular, estrogen actions have been linked to the cognitive domain of verbal memory (Sherwin, 1994, 1998, 2012) and in some cases basic information processing speed (Zec and Trivedi, 2002).

In pre-menopausal women, oral contraceptives (ethinylestradiol and progestins) enhance verbal memory (Gogos *et al.*, 2014). Furthermore, some studies across phases of the menstrual cycle suggest improvements in verbal memory/fluency performance in the late follicular or midluteal phase characterized by high estradiol levels, however, no consistent patterns are observed (Sundström Poromaa and Gingnell, 2014).

Women who undergo menopausal (Weber *et al.*, 2014) and pre- to postpartum transition (Henry and Rendell, 2007; Glynn, 2010) show decreased verbal memory performances, which in some cases are alleviated with hormone replacement therapy (HRT) (Maki and Sundermann, 2009). However, the effect of HRT on memory function after menopause is not clearly understood (Hogervorst & Bandelow, 2010) and may depend on time elapsed between menopause and initiation of HRT (Sherwin, 2009). Randomized, controlled studies of surgically (ovariectomized) postmenopausal women also show surgery-related impairments in verbal episodic memory (Henderson and Sherwin, 2007), which in some women can be rescued with HRT (Sherwin, 2005).

Importantly, ovarian hormones may modulate molecular mechanisms underlying emotion and memory, e.g., serotonin (5-HT) neurotransmission (Lokuge *et al.*, 2011; Meneses, 2013; Borrow and Cameron, 2014; Barth *et al.*, 2015) In peri- and postmenopausal women preliminary data has shown protective effects of transdermal estradiol treatment on tryptophan depletion-induced changes in brain activity during emotional processing (Epperson *et al.*, 2012) and verbal memory impairment (Amin *et al.*, 2006). Furthermore, longer-term estrogen (combined with testosterone) treatment decreased 5-HTT binding in cortical regions in surgically postmenopausal women (Jovanovic *et al.*, 2015). In combination these findings support crosstalk between estrogenic and serotonergic systems of relevance for verbal affective memory processing.

In the present study population we previously showed that ovarian hormone manipulation by GnRHa elicits depressive symptoms, which are associated with both increases in neocortical 5-HTT binding and the magnitude of estradiol decline from baseline (Frokjaer *et al.*, 2015). Here, we evaluate GnRHa-induced effects on verbal affective memory recall, simple reaction time, mental distress, and daily mood fluctuations in the same cohort

(n=61) of premenopausal healthy women. Our main hypotheses were that women undergoing ovarian hormone manipulation exhibit: (1) decreased total verbal memory recall including increased recall for negative relative to positive words and increased mean reaction time latency compared to controls, (2) increased levels of self-reported mental distress and more pronounced mood fluctuations during manipulation compared to controls, and (3) that such effects are partly mediated by changes in neocortical 5-HTT binding.

METHODS

Participants and study design

Sixty-three healthy women participated in this randomised, placebo-controlled, double-blind prospective study. Participants were recruited by internet advertisements as specified earlier (Frokjaer *et al.*, 2015). Exclusion criteria were current and previous psychiatric illness, a significant medical history including premenstrual dysphoric disorder (according to DSM-IV criteria for PMDD), alcohol, tobacco, and illegal drug use, and abnormal neurological and a gynaecological examination, including ultrasound imaging of the uterus and ovaries. One woman did not receive intervention due to anovulation and one became pregnant and could not complete follow-up. Consequently, 61 datasets were available for analyses from women with a mean age of 24.3 ± 4.9 years. The participating women received 3.6 mg GnRHa (goserelin) implant (n=31) or saline injection (n=30) in a natural cycle during the midluteal phase by a gynaecologist not involved in any subsequent data handling. The study is registered and approved by the local ethics committee (protocol ID: H-2-2010-108) and all women signed an informed consent.

Data collection

Data were acquired at baseline in the midfollicular phase (cycle day 6.6 ± 2.2) and at follow-up (16.2 ± 2.6 days after intervention). Mood disturbances were further reported daily during intervention using a secured online survey system (Knudsen *et al.*, 2015). All women, except one, underwent cerebral 5-HTT binding imaging with [^{11}C]DASB PET, at baseline and follow-up. Detailed information regarding the acquisition of PET images, genotyping, and measurement of estradiol concentrations can be found in Frokjaer *et al.* (2015). Based on the

findings reported in Frokjaer *et al.* (2015), we used neocortex as our volume of interest to probe 5-HTT-mediated effects of GnRHa intervention on VAMT-24, SRT, and mental distress.

Measures

The Verbal Affective Memory Test- 24 (VAMT-24)

The VAMT-24 is a computerized test of approximately 25 minutes, which includes three conditions: 1) Learning and Immediate recall (IMM), in which participants view 24 words (target list) on a computer screen and are instructed to recall as many words as possible. This procedure is repeated five times; 2) Short-term recall (STM), in which participants view an interference list of 24 words on the computer screen (I-24) and subsequently are instructed to recall the target; and 3) Long-term recall (LTM), in which participants are asked to do a surprise recall of the target list after a period of 30 minutes. Two lists were used; one at baseline and the other at follow-up. The lists each contained 8 positive, 8 negative, and 8 neutral words (Jensen *et al.*, In press).

The recall scores were highly correlated within each word category in our sample (positive word recall, $r > 0.68$, negative word recall, $r > 0.61$, and neutral word recall, $r > 0.64$). Therefore, we computed a composite memory score for each word category. The computed composite scores for each word category (positive: Total_{Pos}, negative: Total_{Neg}, and neutral: Total_{Neu} words) were defined as: $Total_{cat} = IMM_{cat} + STM_{cat} + LTM_{cat}$, where IMM_{cat} , STM_{cat} and LTM_{cat} are immediate, short-term and long-term VAMT-24 scores respectively, for a given category.

The Simple Reaction Time test (SRT)

The SRT is a computerized test of approximately 6-10 minutes and provides a measure of simple reaction time by delivery of a known stimulus to a known location to elicit a known response. The participants are shown a white square on the screen with a variable interval and are instructed to press a button as soon as they see it. The mean reaction time latency (in ms) is the main outcome of the test.

The NEO Personality Inventory (NEO PI-R)

At baseline all women completed the Danish version (Skovdahl Hansen *et al.*, 2003) of the NEO PI-R (Costa and McCrae, 1992). The NEO PI-R is a self-report inventory, which assesses five major domains of personality and for each domain six sub-facets. For the purpose of this study only the Neuroticism domain was used since it is a known risk factor for MDD in women (Kendler *et al.*, 1993). The Neuroticism domain comprises 48 items rated on a 5-point Likert scale from 0 (strongly disagree) to 4 (strongly agree). Internal consistency (Cronbach's alpha, α) for the Neuroticism domain was high, $\alpha = 0.91$.

The Profile of Mood States (POMS)

The POMS is a psychological rating scale used to assess transient, distinct mood states (McNair and Lorr, 1992). It consists of six factors and a total score of mood disturbance rated by 65 adjectives on a 5-point Likert scale from 1 (not at all) to 5 (extremely) - based on the recollection of the last 24 hours. For the purpose of this study the total mood disturbance score (TMD) was used. Internal consistency for the TMD was high, $\alpha = 0.84$.

The Perceived Stress Scale (PSS)

The PSS is a rating scale, which provides a score of how unpredictable, uncontrollable and overloaded life is perceived (Cohen *et al.*, 1983). It consists of 10 stress-related items rated on a Likert scale from 1 (never) to 5 (very often) based on the recollection of the last two weeks. Internal consistency for the PSS was high, $\alpha = 0.81$.

The Symptom Checklist-92-Revised (SCL-92-R)

The Danish version of the SCL-92-R (Olsen *et al.*, 2006) was used to assess severity of mental distress. The SCL-92-R comprises 92 items rated on a 5-point Likert scale of distress from 0 (none) to 4 (extreme). Nine primary symptom scales and three global indices of distress are derived. For the purpose of this study the Global Severity Index (GSI) was used. Internal consistency for the GSI was high, $\alpha = 0.91$.

The Major Depression Inventory (MDI)

The MDI is a rating scale of depressive symptoms according to DSM-IV and ICD-10 diagnostic criteria (Bech *et al.*, 2001). It comprises 10 items rated on a Likert scale from 0 (never) to 5 (all the time) based on the recollection of the last two weeks. Internal consistency for the MDI was acceptable, $\alpha = 0.63$.

Statistics

All data were processed before un-blinding. Differences in baseline and follow-up outcome measures between the GnRHa and placebo group were examined using analysis of variance. We examined the hypothesized associations stated in the introduction using two main types of structural equation models including some with latent variables (LVs).

The first model type tested direct effects of intervention and effects mediated by changes in neocortical 5-HTT binding on either a LV capturing shared correlation between related outcome measures or a single outcome measure as described in the following (Figure 1). In total, this model type was used to predict four outcomes in four separate models: (1) a LV capturing shared correlation between Total_{Pos}, Total_{Neg}, and Total_{Neu} recall scores (verbal affective memory, LV_{vam}), (2) a LV capturing shared correlation between TMD, GSI, and MDI scores (mental distress, LV_{md}), (3) PSS, and (4) SRT. PSS was initially included in our LV_{md} but model evaluation indicated that it did not load well onto the LV_{md}. Thus, it was treated as a single outcome measure and analyzed separately. Differential effects of intervention status across word categories (Total_{Pos}, Total_{Neg}, and Total_{Neu} recall scores) were tested using a Wald test.

The second model type tested the effects of change in serum estradiol from baseline in the GnRHa group only on the four described outcome measures (i.e., LV_{vam}, LV_{md}, PSS, and SRT) in four separate models (Figure 2). Estradiol concentrations were log transformed (\log_2) consistent with Frokjaer *et al.* (2015).

Baseline outcome measures were included as covariates in each of the two types of models. As such, differences in the outcome measures at retest can be interpreted as change scores (Vickers and Altman, 2001).

The addition of model paths were considered based on Score tests with a false-discovery rate (FDR) of $q < 0.05$ (Benjamini-Hochberg FDR corrected), which specify whether additional paths improve the overall model fit. For models predicting LV_{vam} and LV_{md}, an identifiable model was chosen such that the covariate effects we report can be interpreted in terms of effects on GSI and Total_{Pos} recall (reference scales), respectively. Overall model fit was

determined by comparison to a saturated model and good fit was observed for all models reported, i.e., $p > 0.05$ Likelihood Ratio test of final vs. saturated model.

Potential moderations of intervention effects by Neuroticism were examined using multigroup analyses of the described models. First, a median split of Neuroticism separated the women into low (range: 41-86) and high (range: 87-136) Neuroticism groups. We then estimated the effect of intervention for the low and high Neuroticism groups in two models wherein the intervention effect was either forced to be equivalent between groups or allowed to vary. A moderation effect of Neuroticism was tested comparing the fit of these two models with a Likelihood Ratio test.

Intervention effects on serial daily reports of TMD were examined using mixed model analyses. For each woman, TMD development over the first 15 days after intervention was modeled using a third degree polynomial (i.e., including an intercept, day, day² and day³ both as covariates and as so-called random effects). To model GnRHa effects on TMD development and whether baseline TMD moderated intervention effects, we included an interaction term between intervention status, baseline TMD, and the covariates day, day² and day³. To illustrate such interaction effects we categorized TMD at baseline in three groups (low: TMD < -8, moderate: -8 < TMD < +8, and high: TMD > 8) and re-fitted the model with this categorized TMD at baseline. The data showed a tendency for more variation for higher levels of TMD. Accordingly, we re-fitted the model following a modified logarithmic transformation of the TMD scores ($\log(TMD+50)$). Thus, the final model described in the results is based on the categorized and log-transformed data.

Statistical analyses were carried out in R (v3.0.2) (Team, 2013) using the *lava* package (Holst and Budtz-Jørgensen, 2013) and SAS version 9.4. The alpha level was 0.05 and all reported p-values are uncorrected.

RESULTS

Baseline data

Baseline data collected in the follicular phase for the GnRHa and placebo group are shown in Table 1. At baseline, the two groups did not differ on any of the applied measures. Information regarding intervention timing, hormone responses, and quality of blinding for the study population is detailed in Frokjaer *et al.* (2015).

Direct and indirect effects of GnRHa versus placebo intervention

First, we evaluated intervention effects on specific outcome measures. Results from these analyses are shown in Table 2. For the LV_{vam} outcome model, the shared correlation in VAMT-24 performance across the $Total_{Pos}$, $Total_{Neg}$, and $Total_{Neu}$ recall scores were high (LV_{vam} : all factor loadings, $p < 5.1 \times 10^{-7}$). However, within the described model, there was no direct effect of hormone manipulation with GnRHa on LV_{vam} as compared to placebo ($p = 0.197$).

For the LV_{md} outcome model, the shared correlations in self-reported mental distress across the MDI, TMD, and GSI scores were also high (LV_{md} : all factor loadings, $p < 1.3 \times 10^{-3}$). The overall fit for the model was improved by modeling additional partial correlation between the MDI, TMD, and GSI measures at baseline and follow-up. Again, there was no direct effect of GnRHa intervention on the LV_{md} ($p = 0.929$).

For the model predicting the single outcome measure PSS, no significant direct effect of GnRHa intervention as compared to placebo was observed ($p = 0.134$).

In accordance with our a priori hypothesis, women undergoing GnRHa intervention exhibited a significant increase in SRT as compared to placebo (intervention effect: +7.4 ms, 95% CI: [0.63; 14.1], $p = 0.032$). Thus, ovarian hormone suppression induced a decrease in speed of basic information processing.

GnRHa intervention did not significantly affect neocortical 5-HTT binding in any of the applied models ($p > 0.79$) in accordance with the report by Frokjaer *et al.* (2015). Thus, we did not find evidence that 5-HTT binding mediated effects of GnRHa intervention on outcome measures.

A multivariate regression model with an unstructured correlation matrix was used to describe the three-dimensional response variable of VAMT-24 performance (i.e., Total_{Pos}, Total_{Neg}, and Total_{Neu} recall scores). The test for an overall difference in the effect of intervention on word category recall was non-significant (Wald test: $X^2 = 0.48$, $df = 2$, $p = 0.78$), meaning that GnRHa intervention did not differentially shift performance for Total_{Pos}, Total_{Neg}, and Total_{Neu} recall scores, i.e. produce affective bias.

Moderating effects of Neuroticism

Multigroup analyses showed that Neuroticism had a borderline statistically significant moderation effect on the intervention effect on the PSS outcome measure (Likelihood Ratio test: $X^2 = 3.11$, $df = 1$, $p = 0.077$), such that high Neuroticism women undergoing GnRHa increased self-reported PSS compared to placebo, whereas low Neuroticism women showed little difference between GnRHa and placebo conditions on the PSS outcome measure. We found no evidence for Neuroticism moderating the intervention effect on the LV_{vam}, LV_{md}, and SRT models (all p -values > 0.16).

Effects of estradiol responses to GnRHa intervention

In the second model type (in the GnRHa treated group only), the LV model structure remained well supported by our data with high factor loadings on the LV_{vam} ($p < 2.5 \times 10^{-3}$) and LV_{md} ($p < 1.2 \times 10^{-3}$). Results from these analyses are shown in Table 3. For the model predicting PSS

as a function of changes in serum estradiol from baseline, we found a positive significant effect (PSS: $\beta = 2.11$ PSS/estradiol(nmol/L, \log_2), CI: [0.41 – 3.80], $p = 0.015$). Thus, women who experienced a greater magnitude of decline in estradiol from baseline also self-reported increased levels of PSS. When we examined the effects of changes in serum estradiol from baseline on the LV_{vam} , LV_{md} , and SRT outcome measures, we observed no other significant associations (LV_{vam} , $p = 0.803$, LV_{md} , $p = 0.343$, SRT, $p = 0.440$).

Daily mood reports during GnRHa versus placebo intervention

Although we did not observe a significant main effect of intervention status, TMD at baseline significantly moderated the effect of intervention on the development of daily reported TMD during intervention ($X^2 = 16.0$, $df = 4$, $p = 0.003$) (Figure 3). This finding indicated that GnRHa intervention significantly affected TMD development in women with high TMD at baseline ($X^2 = 10.4$, $df = 4$, $p = 0.034$). When TMD at baseline was replaced by Neuroticism, we observed the same tendencies, i.e., that intervention effect depended on the level of Neuroticism. However, the interaction effect was weaker, but in the high Neuroticism group the intervention effect was statistically significant ($X^2 = 12.7$, $df = 4$, $p = 0.013$).

DISCUSSION

In young healthy women, we for the first time demonstrated decreased speed of basic information processing and increased mood lability in response to a pharmacologically GnRHa-induced ovarian hormone fluctuation relative to placebo. No effects of GnRHa were observed for the latent constructs of verbal affective memory and mental distress scores, respectively. A greater decline in estradiol was associated with increased perceived stress within the GnRHa group. Changes in serotonergic signalling indexed by 5-HTT binding in neocortex did not mediate intervention effects on any of the applied outcome measures.

We found that the GnRHa-induced early hypogonadal state slowed basic information processing as indexed by a simple reaction time task. This finding is consistent with the report that short-term transdermal estradiol therapy (12 weeks) improved simple reaction time in women over 60 years of age compared to placebo (Schiff et al., 2005). Another study found a borderline beneficial effect of hormone therapy (estradiol and norethisterone) on a two-choice reaction time test in pre-menopausal women (Alhola et al., 2010), however, sample sizes were very small in this study (hormone treatment: 7 women, placebo: 7 women). Likewise, postpartum women exhibited reduced levels of general information processing speed in week 32 postpartum (De Groot et al., 2006), which the authors did not find in an earlier study in early pregnancy (De Groot et al., 2003). Thus, fluctuating ovarian hormone levels may adversely influence basic information processing in women; however, more studies are needed to replicate these findings.

In the present study, GnRHa intervention did not affect total verbal affective memory recall or affective bias. Although not directly comparable to our model, targeting a biphasic fluctuation and the early hypogonadal state, it is still somewhat in line with two pharmacological studies where hypogonadism after prolonged treatment with GnRHa and

subsequent ovarian steroid replacement in young healthy women induced no effects on visual or verbal memory performance (Owens *et al.*, 2002; Schmidt *et al.*, 2013). In pre-menopausal women with benign uterine fibroids awaiting surgery, 8 weeks of GnRHa intervention reduced activation in prefrontal regions during verbal encoding compared to waiting list controls (Craig *et al.*, 2007), supporting alterations in the neural mechanisms underlying verbal memory with GnRHa. In the study by Alhola *et al.* (2010), no beneficial effect on memory of hormone therapy was observed for pre-menopausal women, however, hormone therapy increased memory scores in post-menopausal women compared to placebo (n=16). These findings suggest that controlled hormone manipulations are generally well tolerated in healthy pre-menopausal women without significant impairments in verbal memory, while peri- and menopausal women may be more sensitive to verbal memory specific changes in response to hormone manipulations (LeBlanc *et al.*, 2001; Henderson and Sherwin, 2007; Sherwin, 2012).

We speculate that in healthy young women bottom-up processes, i.e. speed of information processing, is slightly compromised by transient hormone fluctuations, whereas top-down processes, i.e., verbal affective memory recall, appear unaffected. Such top-down effects may be most apparent in women in life-phases where changes in hypothalamic-pituitary function alter estrogen sensitivity such as in menopausal transition (Weiss *et al.*, 2004) or in life-phases where a combination of hormonal changes and strain on cognitive top-down processes is evident such as postpartum (caused by, e.g., sleep deprivation, and providing constant physical and emotional care for an infant), as supported by a meta-analysis including 14 studies (Henry and Rendell, 2007).

Future studies in young healthy women may address the combined effects of ovarian hormone manipulations and induced stress, e.g., a social stress test, or apply the proposed

GnRHa-model in high-risk populations, to elucidate risk mechanisms involved in a depressive response to ovarian hormone fluctuations in a context of multiple risk factors.

We found that a biphasic ovarian hormone response to GnRHa, i.e., initial flare-up and subsequent hypogonadism, in a sub-group of women high in state levels of mood disturbances was associated with a progression in mood disturbances so that the initial stimulatory phase decreased levels of mood disturbances (day 4-6), which then increased again coinciding with the hypogonadal phase (day 10-12). The same was observed when anchoring the analyses in the Neuroticism score at baseline; women with high Neuroticism scores were differentially affected by GnRHa (across phases) relative to placebo. However, measures of mood disturbances and mental distress at follow-up (i.e. early hypogonadal state) were not significantly affected by intervention status, but rather the trajectory of mood disturbances differed in this sub-group of women. Thus, the susceptibility to the hormone-triggered mood fluctuations appears to depend on both state and trait aspects of mental status at the time of intervention, partially supporting a vulnerability approach to explain why only some women react with depressive symptoms to fluctuating ovarian hormone levels. This is the first study to collect serial daily mood reports from young healthy women while undergoing a controlled ovarian hormone fluctuation. We propose future studies to expand such a design to elucidate phase specific changes and not solely the hypogonadal state per se.

Contrary to our a priori hypothesis, GnRHa treatment was not associated with increases in the latent construct of self-reported mental distress. In accordance with our results, the two studies by Owens, et al. (2002) and Schmidt, et al. (2013) found no effects of GnRHa-induced hypogonadism on mental distress in healthy women; however, these studies addressed the longer-term established hypogonadal state. Likewise, in 72 healthy young women, longer-term hypogonadism was not associated with elevated self-reported mood-related symptoms,

even in women who experienced severe nighttime hot flushes and disturbed sleep (Ben dor et al., 2013). However, estrogen treatment has been shown to improve mood in women > 65 years age (Gleason *et al.*, 2015). When we obtained information regarding depressive symptoms of the women in this study, based on a semi-structured interview (the Hamilton Depression Rating Scale, HAM-D), we found that GnRHa treatment triggered subclinical depressive symptoms relative to placebo (Frokjaer *et al.*, 2015). Interestingly this effect did not translate clearly to the women's self-reported levels of mental distress, which may point to an important distinction between self-reported versus interview-based information.

It is possible that our model simulates an early onset of hormone-triggered disturbance of mood more driven by somatic changes, as opposed to a manifest depressive state, which would more likely inform top-down elaborative processes such as self-perception and mood. The noted association between greater magnitude of change in estradiol from baseline and increased perceived stress in the GnRHa group may also support this, as stress often precedes a depressive episode. Thus, based on the observed discrepancies between self-reported versus interview-based information, we speculate if GnRHa manipulation induces a form of temporary alexithymia, i.e. inability to identify and verbalize emotions in the self, due to a dissonance between actual mental state and established self-schemata of usual mental state. Alexithymia is a known emotional feature in populations with somatoform and depressive disorders (De Gucht and Heiser, 2003; Duddu *et al.*, 2003), which has been also associated with premenstrual dysphoric disorder (De Berardis et al., 2005) and the development of depressive symptoms in peripartum women (Le *et al.*, 2007). Notable, on several occasions the tester observed that women, who were crying and showing clear signs of emotional distress at follow-up reported that they believed to have received placebo, while they were actually hormone manipulated.

Thus, self-report measures may be useful for elucidating perceived experiences, but may provide only a partial test of the actual impact of pharmacologically induced hypogonadism on processes of relevance for development of the depressed state. Future studies are needed to elucidate the potential mediating role of alexithymia in women undergoing controlled hormone fluctuations or hormone transition phases in life, i.e., pre- to postpartum and menopausal transition, for the development of depressive symptoms.

Methodological considerations

Strengths of this study include the randomized, double-blinded, and placebo-controlled within-subject study design with an extensive set-up of well-validated and reliable psychometric instruments covering baseline to follow-up and daily reports during pharmacological treatment. However, the present findings should be interpreted under the following potentially important methodological limitations. First, women with current and previous psychiatric disorders were excluded from our study population. This is likely to have biased our study population towards low-risk for developing even subclinical depressive symptoms. We may therefore have underestimated the potential effects of a GnRHa-induced biphasic hormone response in more vulnerable populations, i.e., women recovered from depression or with a family history of mood disorders. Second, the VAMT-24 is based on low-arousal emotional words and may as such not be sufficiently sensitive to bottom-up driven changes, which could perhaps be better targeted using high arousal words. Conversely, a major asset of the VAMT-24 is that it is specifically developed for use in healthy samples and, thus, cognitive load was high and ceiling effects were avoided. Third, we did not include a measure of alexithymia to elucidate the role of emotional awareness for self-reported mental distress in response to controlled hormone manipulation.

Acknowledgements

We would like to thank Bente Dall, Gerda Thomsen, Agnete Dyssegaard, and Lone Freyr for their technical assistance with the data collection. We thank Vibeke Dam for her contribution to the figures. We would also like to acknowledge and thank The John and Birthe Meyer Foundation for the donation of the Cyclotron and PET scanner.

Author disclosures

Vibe G. Frokjaer has received honorarium as speaker for H. Lundbeck A/S. Gitte M. Knudsen has received honoraria as Field Editor of the International Journal of Neuropsychopharmacology and as scientific advisor for H. Lundbeck A/S. All other authors declare no biomedical financial interests or conflicts of interest.

Ethical standards

The authors assert that all procedures contributing to this work comply with the ethical standards of the relevant national and institutional committees on human experimentation and with the Helsinki Declaration of 1975, as revised in 2008.

Table 1: Descriptive data for the GnRHa and placebo group at baseline and follow-up with p-values of group differences

Measures	Baseline			Follow-up		
	GnRHa (n=31)	Placebo (n=30)	P-value	GnRHa (n=31)	Placebo (n=30)	P-value
Age in years	23.4 ± 3.3	25.2 ± 6.0	0,19			
BMI (kg/m ²)	23.2 ± 3.8	23.3 ± 3.9	0,94			
Education in years	15.7 ± 1.6	16.1 ± 1.5	0,41			
Neuroticism	85.1 ± 20.6	86.6 ± 21.7	0,79			
TMD	3.5 ± 17.1	2.6 ± 13.6	0,83	2.0 ± 17.4	1.8 ± 15.9	0,96
PSS	9.6 ± 4.8	9.7 ± 5.6	0,84	10.1 ± 6.0	9.0 ± 6.2	0,47
GSI	0.19 ± 0.14	0.25 ± 17.0	0,17	0.20 ± 0.17	0.25 ± 0.21	0,27
MDI	5.5 ± 3.6	5.8 ± 2.9	0,76	7.4 ± 5.0	6.2 ± 4.2	0,34
Total _{Pos}	37.4 ± 5.5	38.7 ± 8.7	0,48	36.6 ± 7.0	36.7 ± 9.7	0,97
Total _{Neg}	34.5 ± 5.6	36.7 ± 7.7	0,19	39.3 ± 6.4	40.1 ± 7.1	0,67
Total _{Neu}	38.0 ± 7.7	40.4 ± 6.4	0,15	42.9 ± 7.5	42.9 ± 6.4	0,97
SRT in msec	229.5 ± 19.5	226.5 ± 21.0	0,57	233.0 ± 20.0	223.2 ± 20.5	0,07
Estradiol (nmol/L)	0.19 ± 0.09	0.19 ± 0.11	0,86	0.07 ± 0.03	0.36 ± 0.25	<0.0001
Neocortex 5-HTT BP _{ND}	0.41 ± 0.05	0.43 ± 0.07	0,36	0.41 ± 0.07	0.42 ± 0.06	0,47

Data is presented with means and standard deviations and p-values denote group (GnRHa versus placebo) differences at baseline and follow-up. TMD: Total Mood Disturbances (POMS), PSS: Perceived Stress scale, GSI: Global Symptom Index (SCL-92-R), MDI: Major Depression Inventory, Total_{pos}: total recall of positive words, Total_{neg}: total recall of negative words, Total_{neu}: total recall of neutral words, SRT: Simple Reaction Time, 5-HTT: serotonin transporter, BP_{ND}: binding potential

Table 2: Model path analyses for direct and indirect effects of intervention

Model outcome	Path analyses (n=61)	Estimate ± SE	P-value	95% Confidence interval	
				2.5%	97.5%
LV_{vam}					
Direct path	LV _{vam} <- intervention	1.65 ± 1.28	0.197	-0.86	4.16
Indirect path	LV _{vam} <- 5-HTT BP _{ND}	15.25 ± 17.92	0.395	-19.87	50.37
Indirect path	5-HTT BP _{ND} <- intervention	0.002 ± 0.01	0.873	-0.02	0.02
LV_{md}					
Direct path	LV _{md} <- intervention	0.004 ± 0.04	0.929	-0.08	0.09
Indirect path	LV _{md} <- 5-HTT BP _{ND}	1.0 ± 0.37	0.006	0.28	1.72
Indirect path	5-HTT BP _{ND} <- intervention	0.002 ± 0.01	0.873	0.019	0.02
PSS					
Direct path	PSS <- intervention	1.43 ± 0.95	0.134	-0.44	3.3
Indirect path	PSS <- 5-HTT BP _{ND}	-14.4 ± 10.28	0.161	-34.57	5.75
Indirect path	5-HTT BP _{ND} <- intervention	0.002 ± 0.01	0.873	-0.02	0.02
SRT					
Direct path	SRT <- intervention	7.4 ± 3.44	0.032	0.63	14.1
Indirect path	SRT <- 5-HTT BP _{ND}	-25.44 ± 44.2	0.565	-112.0	61.3
Indirect path	5-HTT BP _{ND} <- intervention	0.003 ± 0.01	0.792	-0.018	0.023

Data is presented with estimates and SE (standard errors) including 95% confidence interval. P-values denote the direct and indirect effects of the delineated model paths (<-). LV_{vam}: The shared correlation across total recall of positive words, total recall of negative words, and total recall of neutral words, LV_{md}: The shared correlation across Total Mood Disturbances (TMD), Global Symptom Index (GSI), and Major Depression Inventory (MDI), PSS: Perceived Stress scale, SRT: Simple reaction time, 5-HTT: serotonin transporter, BP_{ND}: binding potential

Figure 1: Direct and indirect effects through 5-HTT binding of GnRH α versus placebo intervention on estimated outcome measures

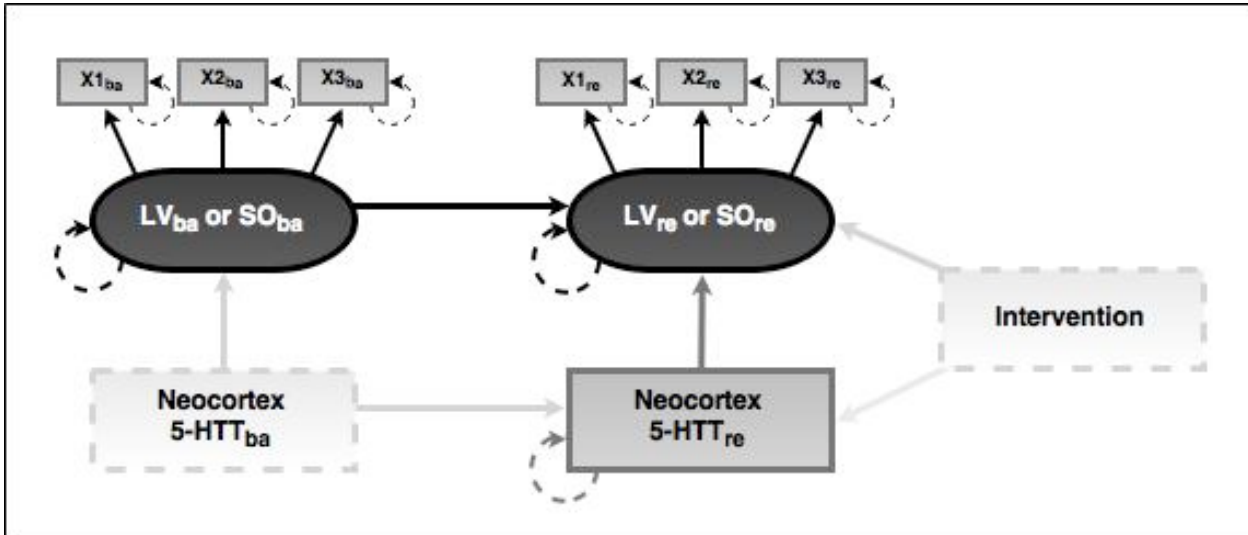

The figure shows a schematic overview of the applied structural equation model including either a latent variable or a single outcome measure. The model paths of interest include intervention status predicting the estimated outcome measure at rescan and neocortex 5-HTT binding at rescan. The estimated outcome measure and neocortex 5-HTT binding at rescan are predicted by the estimated outcome measure and neocortex 5-HTT binding at baseline, respectively, modeling individual differences in these measures at baseline. To allow for an association at baseline, there is a delineated model path from neocortex 5-HTT binding at baseline to the estimated outcome measure at baseline. The black circles represent the latent variable or single outcome measure at baseline and retest, respectively (LV_{ba} = latent variable and SO_{ba} = single outcome at baseline; LV_{re} = latent variable and SO_{re} = single outcome at rescan). The grey boxes predicted by the latent variable represent observed data. For the latent construct of verbal affective memory (LV_{vam}) this includes $Total_{pos}$, $Total_{Neg}$, and $Total_{Neu}$ recall scores whereas for the latent construct of mental distress (LV_{md}) this includes TMD, GSI, and MDI scores. The hatched grey lines indicate variables estimated with error.

Figure 2: Effects of change in estradiol on estimated outcome measures in the GnRHa group

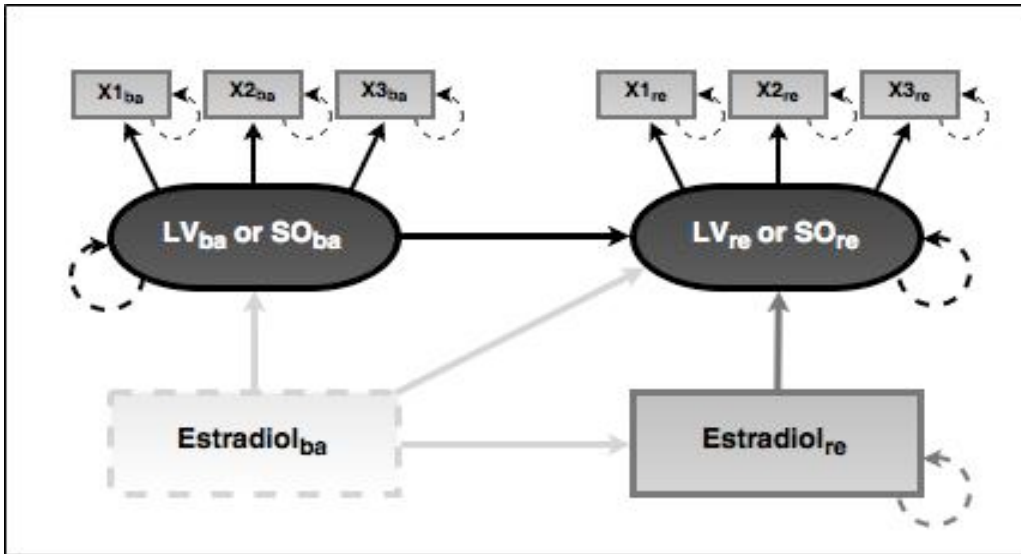

The figure shows a schematic overview of the applied structural equation model including either a latent variable or a single outcome measure. Estradiol at retest predicting the estimated outcome measure at rescans represents the main model path of interest. The estimated outcome measure at rescans is also predicted by the estimated outcome measure at baseline and estradiol at baseline thereby modeling individual differences in these measures at baseline. Furthermore, there is a delineated model path from estradiol at baseline to estradiol at rescans. The black circles represent the latent variable or single outcome measure at baseline and rescans, (LV_{ba} = latent variable and SO_{ba} = single outcome at baseline; LV_{re} = latent variable and SO_{re} = single outcome at rescans). The grey boxes predicted by the latent variable represent observed data. For the latent construct of verbal affective memory (LV_{vam}) this includes Total_{Pos}, Total_{Neg}, and Total_{Neu} recall scores whereas for the latent construct of mental distress (LV_{md}) this includes TMD, GSI, and MDI scores. The hatched grey lines indicate variables estimated with error.

Figure 3: Interaction effect between intervention status and TMD at baseline on the development of daily reported TMD during intervention

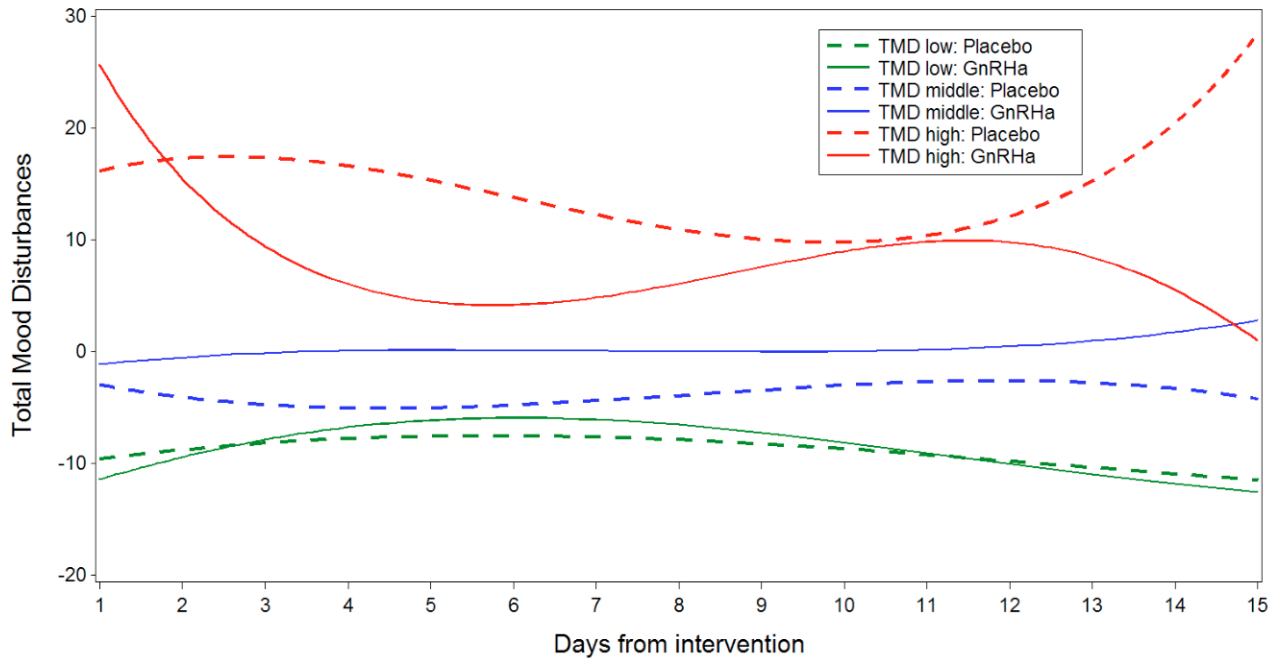

The figure shows the development of serial daily TMD as a function of intervention group and baseline TMD (baseline TMD groups, low: TMD < -8, moderate: -8 < TMD < +8, high: TMD > 8). Baseline TMD significantly moderated the GnRHa intervention effect on TMD development ($p = 0.003$). Specifically, GnRHa intervention significantly affected TMD development in women with high baseline TMD whereas there was no effect of intervention in women with moderate or low baseline TMD. When we tested whether each of the TMD trajectories was constant, only for women undergoing GnRHa intervention with high TMD scores at baseline could the hypothesis of a time constant TMD level be rejected (0.016). Thus, only for this sub-group of women receiving GnRHa did the development of TMD during intervention deviate significantly from a straight line. TMD: Total Mood Disturbances, GnRHa: Gonadotropin-Releasing Hormone agonist.

REFERENCES

- Amin, Z., Gueorguieva, R., Cappiello, A., Czarkowski, K. A., Stiklus, S., Anderson, G. M., Naftolin, F. & Epperson, C. N.** (2006). Estradiol and Tryptophan Depletion Interact to Modulate Cognition in Menopausal Women. *Neuropsychopharmacology : official publication of the American College of Neuropsychopharmacology* **31**, 2489-2497.
- Barth, C., Villringer, A. & Sacher, J.** (2015). Sex hormones affect neurotransmitters and shape the adult female brain during hormonal transition periods. *Front Neurosci* **9**, 37.
- Bech, P., Rasmussen, N. A., Olsen, L. R., Noerholm, V. & Abildgaard, W.** (2001). The sensitivity and specificity of the Major Depression Inventory, using the Present State Examination as the index of diagnostic validity. *Journal of affective disorders* **66**, 159-164.
- Borrow, A. P. & Cameron, N. M.** (2014). Estrogenic mediation of serotonergic and neurotrophic systems: Implications for female mood disorders. *Progress in Neuro-Psychopharmacology and Biological Psychiatry* **54**, 13-25.
- Chakraborti, A., Gulati, K. & Ray, A.** (2007). Estrogen Actions on Brain and Behavior: Recent Insights and Future Challenges. In *Reviews in the neurosciences*, p. 395.
- Cohen, S., Kamarck, T. & Mermelstein, R.** (1983). A global measure of perceived stress. *Journal of health and social behavior* **24**, 385-96.
- Comasco, E., Frøkjær, V. G. & Sundström Poromaa, I.** (2014). Functional and molecular neuroimaging of menopause and hormone replacement therapy. *Frontiers in Neuroscience* **8**.
- Costa, P. T. & McCrae, R. R.** (1992). *Professional Manual for Revised NEO Personality Inventory*. Psychological Assessment Resources: Odessa, Florida.
- Craig, M. C., Fletcher, P. C., Daly, E. M., Rymer, J., Cutter, W. J., Brammer, M., Giampietro, V., Wickham, H., Maki, P. M. & Murphy, D. G.** (2007). Gonadotropin hormone releasing hormone agonists alter prefrontal function during verbal encoding in young women. *Psychoneuroendocrinology* **32**, 1116-27.
- De Gucht, V. & Heiser, W.** (2003). Alexithymia and somatisation: A quantitative review of the literature. *Journal of psychosomatic research* **54**, 425-434.
- Deecher, D., Andree, T. H., Sloan, D. & Schechter, L. E.** (2008). From menarche to menopause: Exploring the underlying biology of depression in women experiencing hormonal changes. *Psychoneuroendocrinology* **33**, 3-17.
- Duddu, V., Isaac, M. K. & Chaturvedi, S. K.** (2003). Alexithymia in somatoform and depressive disorders. *Journal of psychosomatic research* **54**, 435-438.
- Epperson, C. N., Amin, Z., Ruparel, K., Gur, R. & Loughhead, J.** (2012). Interactive effects of estrogen and serotonin on brain activation during working memory and affective processing in menopausal women. *Psychoneuroendocrinology* **37**, 372-82.
- Freeman, E. W., Sammel, M. D., Boorman, D. W. & Zhang, R.** (2014). Longitudinal pattern of depressive symptoms around natural menopause. *JAMA Psychiatry* **71**, 36-43.
- Freeman, E. W., Sammel, M. D., Lin, H. & Nelson, D. B.** (2006). Associations of hormones and menopausal status with depressed mood in women with no history of depression. *Archives of general psychiatry* **63**, 375-382.
- Gavin, N. I., Gaynes, B. N., Lohr, K. N., Meltzer-Brody, S., Gartlehner, G. & Swinson, T.** (2005). Perinatal depression: a systematic review of prevalence and incidence. *Obstet Gynecol* **106**, 1071-83.
- Gleason, C. E., Dowling, N. M., Wharton, W., Manson, J. E., Miller, V. M., Atwood, C. S., Brinton, E. A., Cedars, M. I., Lobo, R. A., Merriam, G. R., Neal-Perry, G., Santoro, N. F., Taylor, H. S., Black, D. M., Budoff, M. J., Hodis, H. N., Naftolin, F., Harman, S. M. & Asthana,**

- S.** (2015). Effects of Hormone Therapy on Cognition and Mood in Recently Postmenopausal Women: Findings from the Randomized, Controlled KEEPS-Cognitive and Affective Study. *PLoS medicine* **12**, e1001833.
- Glynn, L. M.** (2010). Giving birth to a new brain: hormone exposures of pregnancy influence human memory. *Psychoneuroendocrinology* **35**, 1148-55.
- Henderson, V. W. & Sherwin, B. B.** (2007). Surgical versus natural menopause: cognitive issues. *Menopause* **14**, 572-9.
- Henry, J. D. & Rendell, P. G.** (2007). A review of the impact of pregnancy on memory function. *Journal of clinical and experimental neuropsychology* **29**, 793-803.
- Holst, K. & Budtz-Jørgensen, E.** (2013). Linear latent variable models: the lava-package. *Comput Stat*, 1-68.
- Jensen, C. G., Hjordt, L. V., Stenbæk, D. S., Andersen, E., Back, S. K., Lansner, J., Hageman, I., Dam, H., Porsmose, A., Knudsen, G. M., Frokjaer, V. G. & Hasselbalch, S. G.** (In press). Development and psychometric validation of the verbal affective memory test. *Memory*.
- Jovanovic, H., Kocoska-Maras, L., Radestad, A. F., Halldin, C., Borg, J., Hirschberg, A. L. & Nordstrom, A. L.** (2015). Effects of estrogen and testosterone treatment on serotonin transporter binding in the brain of surgically postmenopausal women--a PET study. *NeuroImage* **106**, 47-54.
- Kendler, K. S., Neale, M. C., Kessler, R. C., Heath, A. C. & Eaves, L. J.** (1993). A longitudinal twin study of personality and major depression in women. *Archives of general psychiatry* **50**, 853-862.
- Kessler, R. C., Berglund, P., Demler, O., Jin, R., Merikangas, K. R. & Walters, E. E.** (2005). Lifetime prevalence and age-of-onset distributions of dsm-iv disorders in the national comorbidity survey replication. *Archives of general psychiatry* **62**, 593-602.
- Kessler, R. C., McGonagle, K. A., Swartz, M., Blazer, D. G. & Nelson, C. B.** (1993). Sex and depression in the National Comorbidity Survey I: Lifetime prevalence, chronicity and recurrence. *Journal of affective disorders* **29**, 85-96.
- Le, H. N., Ramos, M. A. & Muñoz, R. F.** (2007). The relationship between alexithymia and perinatal depressive symptomatology. *Journal of psychosomatic research* **62**, 215-222.
- Le Strat, Y., Dubertret, C. & Le Foll, B.** (2011). Prevalence and correlates of major depressive episode in pregnant and postpartum women in the United States. *J Affect Disord* **135**, 128-38.
- LeBlanc, E. S., Janowsky, J., Chan, B. K. & Nelson, H. D.** (2001). Hormone replacement therapy and cognition: systematic review and meta-analysis. *JAMA : the journal of the American Medical Association* **285**, 1489-99.
- Lokuge, S., Frey, B. N., Foster, J. A., Soares, C. N. & Steiner, M.** (2011). Depression in women: windows of vulnerability and new insights into the link between estrogen and serotonin. *The Journal of clinical psychiatry* **72**, e1563-9.
- Maki, P. M. & Sundermann, E.** (2009). Hormone therapy and cognitive function. *Human reproduction update* **15**, 667-681.
- Marcus, S. M., Kerber, K. B., Rush, A. J., Wisniewski, S. R., Nierenberg, A., Balasubramani, G. K., Ritz, L., Kornstein, S., Young, E. A. & Trivedi, M. H.** (2008). Sex differences in depression symptoms in treatment-seeking adults: confirmatory analyses from the Sequenced Treatment Alternatives to Relieve Depression study. *Comprehensive psychiatry* **49**, 238-246.
- McEwen, B. S., Akama, K. T., Spencer-Segal, J. L., Milner, T. A. & Waters, E. M.** (2012). Estrogen effects on the brain: Actions beyond the hypothalamus via novel mechanisms. *Behavioral neuroscience* **126**, 4-16.

- Meneses, A.** (2013). 5-HT systems: emergent targets for memory formation and memory alterations. In *Reviews in the neurosciences*, p. 629.
- Munk-Olsen, T., Laursen, T. M., Pedersen, C. B., Mors, O. & Mortensen, P. B.** (2006). New parents and mental disorders: a population-based register study. *JAMA* **296**, 2582-9.
- O'Hara, M., Swain, AM** (1996). Rates and risk of postpartum depression- a meta-analysis. *Int Rev Psychiatry* **8**, 37-54.
- Olsen, L. R., Mortensen, E. L. & Bech, P.** (2006). Mental distress in the Danish general population. *Acta psychiatrica Scandinavica* **113**, 477-84.
- Owens, J. F., Matthews, K. A. & Everson, S. A.** (2002). Cognitive function effects of suppressing ovarian hormones in young women. *Menopause* **9**, 227-235.
- Schmidt, #160, J., P., Keenan, A., P., Schenkel, A., L., Berlin, Kate, Gibson, Carolyn, Rubinow & R., D.** (2013). *Cognitive performance in healthy women during induced hypogonadism and ovarian steroid addback*. Springer: Heidelberg, ALLEMAGNE.
- Sherwin, B. B.** (1994). Estrogenic effects on memory in women. *Annals of the New York Academy of Sciences* **743**, 213-30; discussion 230-1.
- Sherwin, B. B.** (1998). Estrogen and cognitive functioning in women. *Proc Soc Exp Biol Med* **217**, 17-22.
- Sherwin, B. B.** (2005). Surgical menopause, estrogen, and cognitive function in women: what do the findings tell us? *Annals of the New York Academy of Sciences* **1052**, 3-10.
- Sherwin, B. B.** (2009). Estrogen therapy: is time of initiation critical for neuroprotection? *Nature reviews. Endocrinology* **5**, 620-627.
- Sherwin, B. B.** (2012). Estrogen and cognitive functioning in women: lessons we have learned. *Behavioral neuroscience* **126**, 123-7.
- Skovdahl Hansen, H., Mortensen, E. L. & Schiøtz, H. K.** (2003). *NEO PI-R. Manual - clinical. Danish version*. Dansk Psykologisk Forlag: Copenhagen.
- Sundström Poromaa, I. S. & Gingnell, M.** (2014). Menstrual cycle influence on cognitive function and emotion processing - from the reproductive perspective. *Frontiers in Neuroscience* **8**.
- Team, R. C.** (2013). *R: A language and environment for statistical computing*. R Foundation for Statistical Computing: Vienna, Austria.
- Toffoletto, S., Lanzenberger, R., Gingnell, M., Sundström-Poromaa, I. & Comasco, E.** (2014). Emotional and cognitive functional imaging of estrogen and progesterone effects in the female human brain: A systematic review. *Psychoneuroendocrinology* **50**, 28-52.
- Vickers, A. J. & Altman, D. G.** (2001). *Analysing controlled trials with baseline and follow up measurements*.
- Weber, M. T., Maki, P. M. & McDermott, M. P.** (2014). Cognition and mood in perimenopause: a systematic review and meta-analysis. *The Journal of steroid biochemistry and molecular biology* **142**, 90-8.
- Weiss, G., Skurnick, J. H., Goldsmith, L. T., Santoro, N. F. & Park, S. J.** (2004). MENopause and hypothalamic-pituitary sensitivity to estrogen. *JAMA : the journal of the American Medical Association* **292**, 2991-2996.
- Zec, R. F. & Trivedi, M. A.** (2002). The effects of estrogen replacement therapy on neuropsychological functioning in postmenopausal women with and without dementia: a critical and theoretical review. *Neuropsychology review* **12**, 65-109.



DECLARATION OF CO-AUTHORSHIP

Information on PhD student:	
Name of PhD student	Dea Siggaard Stenbæk
E-mail	dea@nru.dk
Date of birth	12-05-1976
Work place	Neurobiology Research Unit, Rigshospitalet
Principal supervisor	Steen Gregers Hasselbalch

Title of PhD thesis:
Sex-steroid hormone manipulations and serotonergic neurotransmission in relation to verbal affective memory recall, simple reaction time, and mental distress

This declaration concerns the following article:
Mental distress and personality in women undergoing GnRH antagonist versus GnRH agonist protocols for assisted reproductive technology

The PhD student's contribution to the article: <i>(please use the scale (A,B,C) below as benchmark*)</i>	(A,B,C)
1. Formulation/identification of the scientific problem that from theoretical questions need to be clarified. This includes a condensation of the problem to specific scientific questions that is judged to be answerable by experiments	B
2. Planning of the experiments and methodology design, including selection of methods and method development	C
3. Involvement in the experimental work	B
4. Presentation, interpretation and discussion in a journal article format of obtained data	C

*Benchmark scale of the PhD student's contribution to the article		
A. refers to:	Has contributed to the co-operation	0-33 %
B. refers to:	Has contributed considerably to the co-operation	34-66 %
C. refers to:	Has predominantly executed the work independently	67-100 %

Signature of the co-authors:			
Date:	Name:	Title:	Signature:
7/7-2015	Vibe Gedsø Frokjaer (corresponding and senior author)	MD, PhD	
	Taftager, Mette	MD, PhD	
	Hjorret, Liv V.	MSc	

	Jensen, Peter	MSc	
	Holst, Klaus Kähler	MSc, PhD	
	Bryndorf, Tue	MD, PhD	

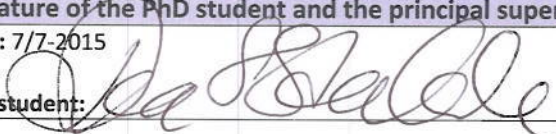
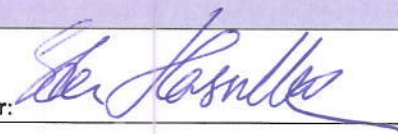
Signature of the PhD student and the principal supervisor:	
Date: 7/7-2015	Date: 7/7-2015
PhD student: 	Principal supervisor: 

Holland, Trine BSc

Bogstad, Jeanette MD, DMSc

Pihborg, Anja MD, PhD

Hornness, Peter MD, PhD

Vibe Frøkjær has signed on
behalf of all co-authors



DECLARATION OF CO-AUTHORSHIP

Information on PhD student:	
Name of PhD student	Dea Siggaard Stenbæk
E-mail	dea@nru.dk
Date of birth	12-05-1976
Work place	Neurobiology Research Unit, Rigshospitalet
Principal supervisor	Steen Gregers Hasselbalch

Title of PhD thesis:
Sex-steroid hormone manipulations and serotonergic neurotransmission in relation to verbal affective memory recall, simple reaction time, and mental distress

This declaration concerns the following article:
Cerebral serotonin 4 receptor binding inversely associated with affective memory

The PhD student's contribution to the article: <i>(please use the scale (A,B,C) below as benchmark*)</i>	(A,B,C)
1. Formulation/identification of the scientific problem that from theoretical questions need to be clarified. This includes a condensation of the problem to specific scientific questions that is judged to be answerable by experiments	B
2. Planning of the experiments and methodology design, including selection of methods and method development	B
3. Involvement in the experimental work	B
4. Presentation, interpretation and discussion in a journal article format of obtained data	C

*Benchmark scale of the PhD student's contribution to the article		
A. refers to:	Has contributed to the co-operation	0-33 %
B. refers to:	Has contributed considerably to the co-operation	34-66 %
C. refers to:	Has predominantly executed the work independently	67-100 %

Signature of the co-authors:			
Date:	Name:	Title:	Signature:
7/7-2015	Gitte Moos Knudsen (corresponding and senior author)	MD, PhD	
	Fisher, Patrick	MSc, PhD	
	Andersen Emil	stud. psych	

	Hjardt, Liv V.	MSc	
	Holst, Klaus Kähler	MSc, PhD	
	Mc Mahon, Brenda	MD	

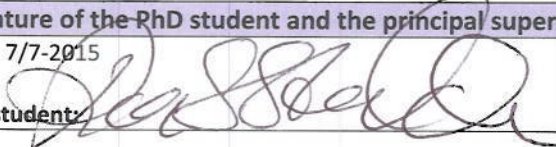
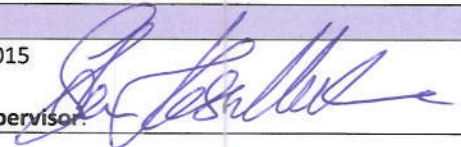
Signature of the PhD student and the principal supervisor:	
Date: 7/7-2015	Date: 7/7-2015
PhD student: 	Principal supervisor: 

Hasselbalch, Steen AMSc (main supervisor)
 Frøkjær, Vibe V. MD, PhD

Gitu Moos Pundsen has signed on behalf of all co-authors.



DECLARATION OF CO-AUTHORSHIP

Information on PhD student:	
Name of PhD student	Dea Siggaard Stenbæk
E-mail	dea@nru.dk
Date of birth	12-05-1976
Work place	Neurobiology Research Unit, Rigshospitalet
Principal supervisor	Steen Gregers Hasselbalch

Title of PhD thesis:
Sex-steroid hormone manipulations and serotonergic neurotransmission in relation to verbal affective memory recall, simple reaction time, and mental distress

This declaration concerns the following article:
Transient sex-steroid hormone manipulation slows reaction time and increases mood variability but does not affect verbal memory in young healthy women

The PhD student's contribution to the article: (please use the scale (A,B,C) below as benchmark*)	(A,B,C)
1. Formulation/identification of the scientific problem that from theoretical questions need to be clarified. This includes a condensation of the problem to specific scientific questions that is judged to be answerable by experiments	B
2. Planning of the experiments and methodology design, including selection of methods and method development	B
3. Involvement in the experimental work	C
4. Presentation, interpretation and discussion in a journal article format of obtained data	C

*Benchmark scale of the PhD student's contribution to the article		
A. refers to:	Has contributed to the co-operation	0-33 %
B. refers to:	Has contributed considerably to the co-operation	34-66 %
C. refers to:	Has predominantly executed the work independently	67-100 %

Signature of the co-authors:			
Date:	Name:	Title:	Signature:
7/7-2015	Vibe Gedsø Frokjaer (corresponding and senior author)	MD, PhD	
	Fisher, Patrick	MSc, PhD	
	Budtz-Jørgensen, Esben	MSc, PhD	

	Pihborg, Anja	MD, PhD	
	Hjorvat, Liv V.	MSc	
	Jensen, Peter S.	MSc	

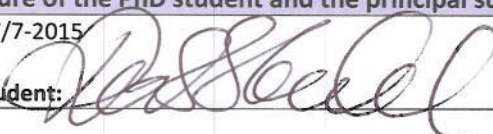
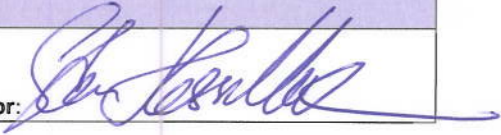
Signature of the PhD student and the principal supervisor:	
Date: 7/7-2015	Date: 7/7-2015
PhD student: 	Principal supervisor: 

Knudsen, Gitta M. MD, DMSc

Vibe Frøkjær has signed on behalf of all co-authors